

WHOLESALE
CATALOG

PENS

PARTS

TOOLS

ACCESSORIES

PenCraft

5 BROMFIELD STREET, BOSTON, MASS.

PEN REPAIRS MEAN
EXTRA PROFITS FOR YOU!

Make More Money

INCREASE PROFITABLE TRAFFIC IN YOUR STORE

BUILD MORE SATISFIED CUSTOMERS

CASH IN ON A STEADY CONSISTENT BUSINESS . . .

*The Investment Is Small . . .
The Profits Are Big*

MILLIONS OF PENS
REQUIRE REPAIRS DAILY

Hundreds of Pens in Your Community Require Servicing . . . Get This
Business and Bring New Customers to Your Store

PenCraft Tells You How in the Following Pages . . .

THE PUBLIC BUYS WHERE IT GETS SERVICE—

COMPLETE PEN REPAIR KIT

Enough to Start Your New Department

HERE'S WHAT YOU GET

1. Pencraft Repair Manual
2. 6 Dozen Assorted Sacs
3. Sac Spreader
4. Sac Hook
5. Alcohol Lamp
6. Pen Section Block
7. Driver Pilot
8. Buffing Stick
9. Polishing Rouge
10. Pen Point Pliers
11. Magnifying Glass
12. Smoothing Paper
13. Hammer
14. Repair Sign
15. Sac Cement
16. Celluloid Cement
17. Cleaning Bulb
18. Feed Brush
19. Flat File
20. Triangular File
21. Drill Chuck
22. 3 Drills
23. Bench Vise
24. Burnisher
25. Tweezers
26. Dozen Assorted Feeds
27. Dozen Assorted Press Bars
28. Doz. Asst. Process Points
29. 100 Repair Envelopes
30. Round Brush for Caps

As Illustrated on Opposite Page



Anyone with the least bit of mechanical ability should experience little trouble in repairing fountain pens if the operation is followed out according to steps described in THE PENCRAFT MANUAL.

FREE WITH REPAIR KIT

WHEN ORDERED
SEPARATELY

50c PER COPY

OUR MONEY BACK GUARANTEE

We absolutely agree to refund your money (less 10 percent for handling charges) for any merchandise that you cannot sell, or do not wish to keep, returned to us in first-class condition within 30 days from date of purchase.

PENCRAFT, INC., 5 BROMFIELD STREET, BOSTON, MASS.

DO YOUR OWN REPAIRING—ORDER A KIT NOW

ALL FOR ONLY \$11.50

WE PAY POSTAGE

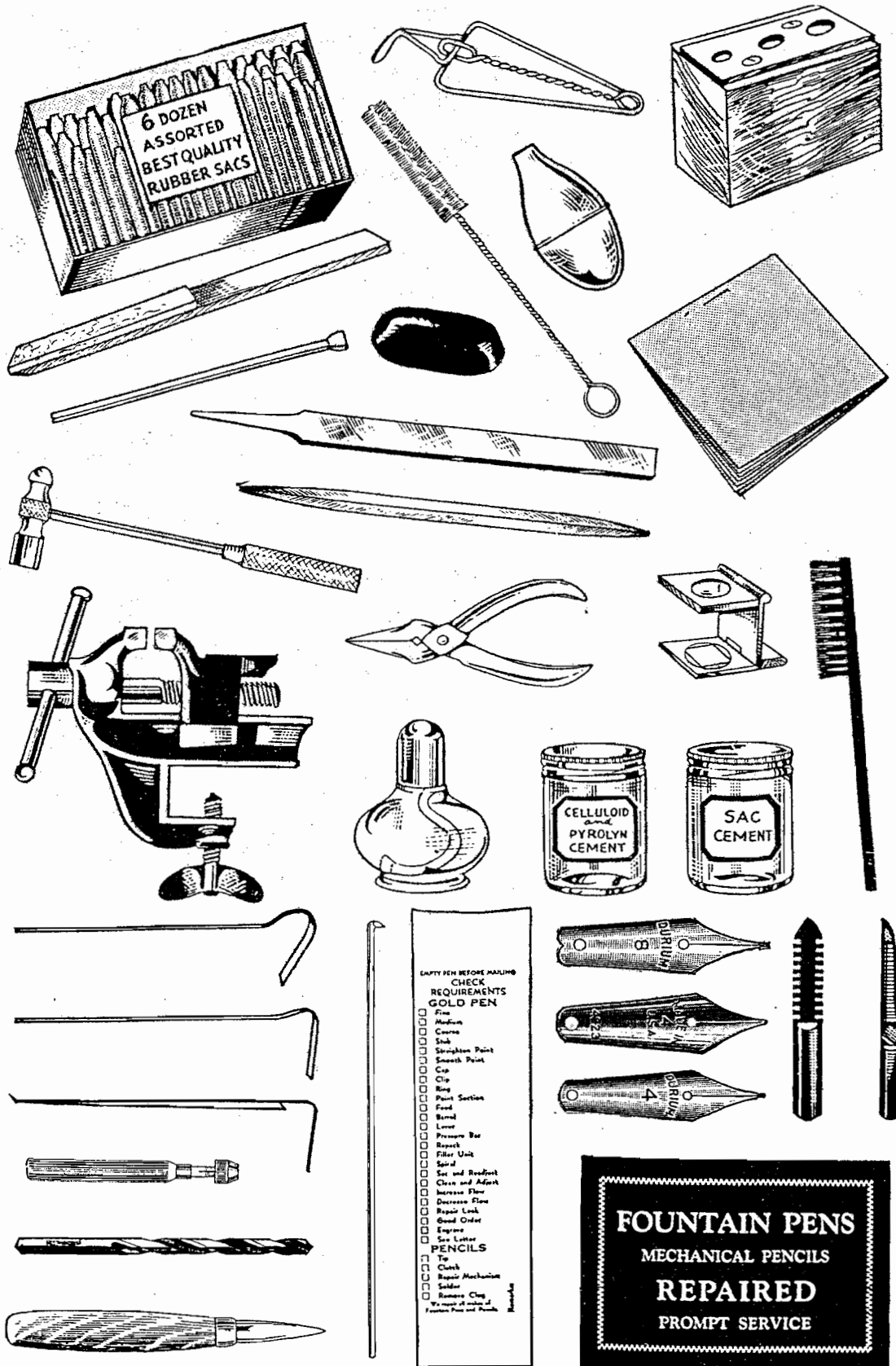

PENCRAFT, INC., 5 BROMFIELD STREET, BOSTON, MASS.

THE LEADING PEN ACCESSORY HOUSE IN THE U.S.A.

SPRING PRESSURE BARS

No. 3—Plain—Long or Short
Per dozen20c—gross \$1.20

No. 7—Same type as No. 3
Heavier spring, dozen ..25c—gross \$1.50

Double Action—Long or Short
Per dozen35c—gross \$2.90

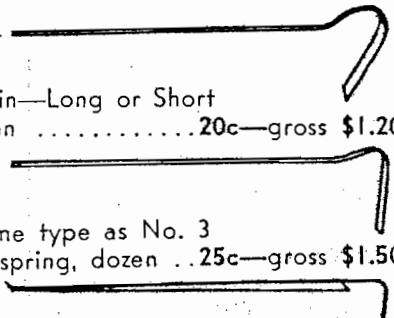

PARKER PRESSURE BARS

For Parker Duofold and Parker
Lucky Curve

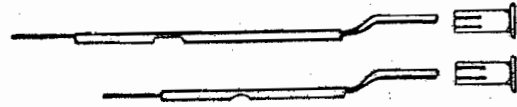

10c each—\$1.00 dozen
3 doz. asst. \$2.50

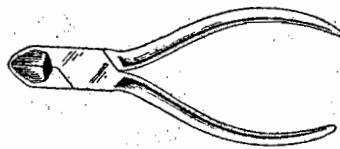

DIAGONAL CUTTING PLIERS

Forged Steel—Polished
Has Sharp Cutting Edge
\$1.00 each

BEST QUALITY—HIGH FINISH
ATTACHABLE CLIPS

✓ Gold Filled 10c each—\$1.00 doz.
Nickel Silver 5c each—50c doz.

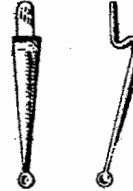

WATERMAN
BOX LEVERS

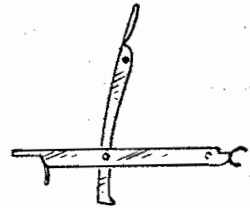

CHROME 20c EACH
GOLD FILLED...33c EACH
FOR SIZE WHEN
ORDERING
SEE BUTT END OF
BARREL

FOUNTAIN PEN BOXES

For display or mailing, strong and
durable, covered with brown kraft
paper 6 1/8 in. by 11/16 in.,
30c doz. \$2.00 per hundred
\$16.00 per thousand

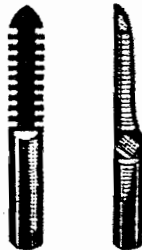
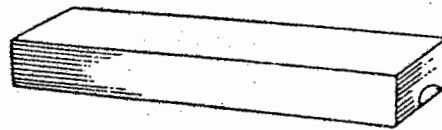

COMB FEEDS
(Clean Cut)
10c Each
60c Doz.

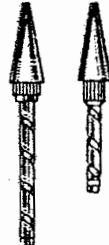

PENCIL MOVEMENTS
Gold Filled Front or
Chrome
15c Each
\$1.25 Dozen

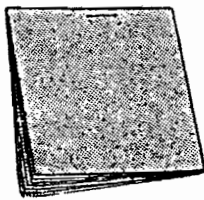

Smoothen Points with
TRIPLE-O-FRENCH
EMERY PAPER
6 Sheets 20c

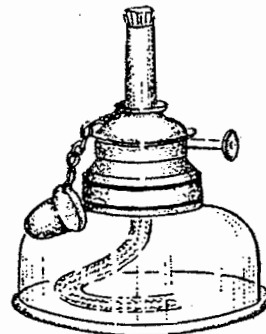

ALCOHOL LAMP
(Uses denatured
or wood alcohol)
To heat the feed or
hard rubber parts to
make them pliable.
Used for soldering.
1 oz. size 50c
2 oz. size 65c

Round Bristle
BRUSHES

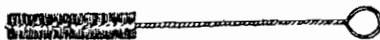

For cleaning the insides
of inky caps and barrels.
15c Each \$1.50 Dozen



CLEANING BULB

Saves time and breakage, flushes sediment
from point section and feeds without re-
quiring removal of pen point.
15c Each \$1.50 Dozen

PEN REPAIR ENVELOPES

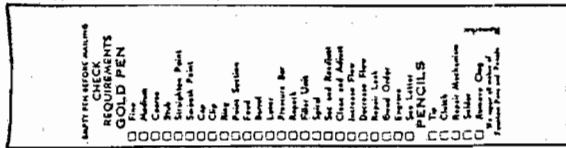

This space for your address

**FOUNTAIN PENS
MECHANICAL PENCILS
REPAIRED**
PROMPT / EFFICIENT SERVICE

MAKE _____ DATE _____
REPAIR NO. _____ DEALER _____
OWNER _____

100—60c 500—\$2.50 1000—\$4.50
3000 Your Name and Address Imprinted
 \$15.50
5000 Your Name and Address Imprinted
 \$24.00

**THESE LOW PRICES CANNOT BE
DUPLICATED**

BURNISHER
Tempered Steel
Highly Polished

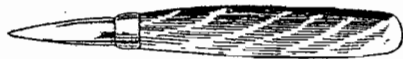

Lacquered Wood Handle
50c Each

SAC SPREADERS

For Stretching
Rubber Sac

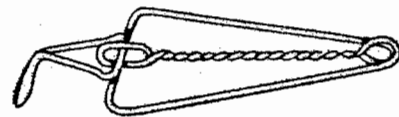

25c Each

HIGH POWER MAGNIFIER

1/4" x 1/4" Lens
50c

1/2" x 1/2" Lens
75c

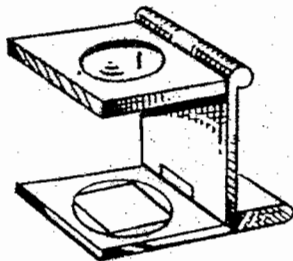

**PEN
SECTION
BLOCK**

Used for
Driving
feed and
gold pen
from point
section.

60c

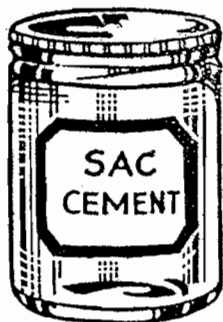
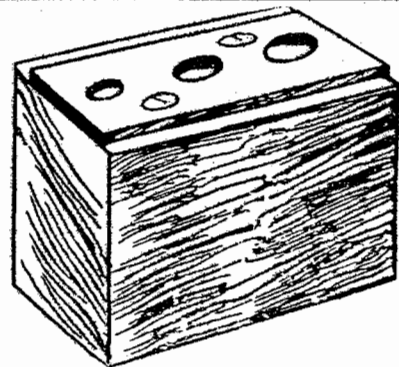

SAC CEMENT

For attaching rubber
sac to point section.

15c Bottle

Will mend anything
made of celluloid,
tortoise shell or py-
rolyn. Practical and
economical.

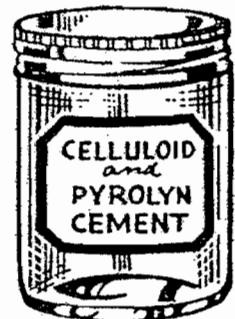

25c

FOUNTAIN PENS
MECHANICAL PENCILS
REPAIRED
PROMPT SERVICE

A sign that will bring business in for you. Your first repair job pays for it. 10 x 7 with silver letters and silver borders on a black background.

25c EACH

THE PUBLIC BUYS WHERE IT GETS SERVICE

NONE BETTER—FIRST QUALITY HARD IRIIDIUM 14K GOLD POINTS

Tipped with the highest quality IRIIDIUM to insure long wear, smoothness and complete writing satisfaction. High standards of manufacture plus rigid inspection is your guarantee of absolute quality.

Complete Assortment \$3.95

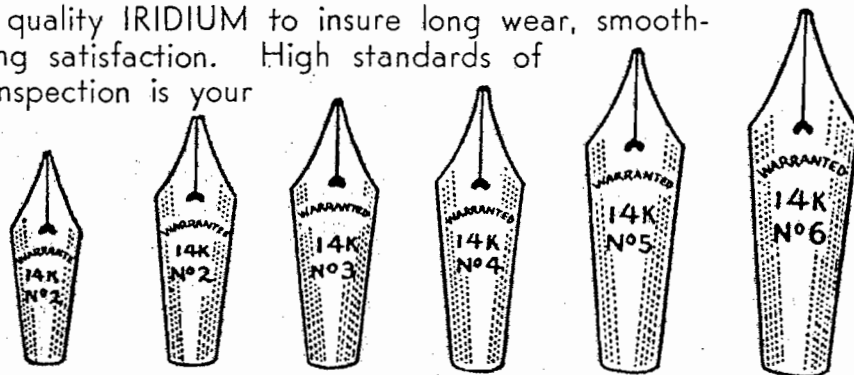

Each	40c	50c	65c	75c	85c	95c
Dozen	\$4.50	\$5.90	\$7.50	\$8.70	\$9.90	\$11.00

SAVE MORE THAN HALF ON THIS ASSORTMENT

Special value 12 gold pen point assortment with alloy IRIIDIUM tip points. Per Dozen. Regular Value \$12.00 \$5.25

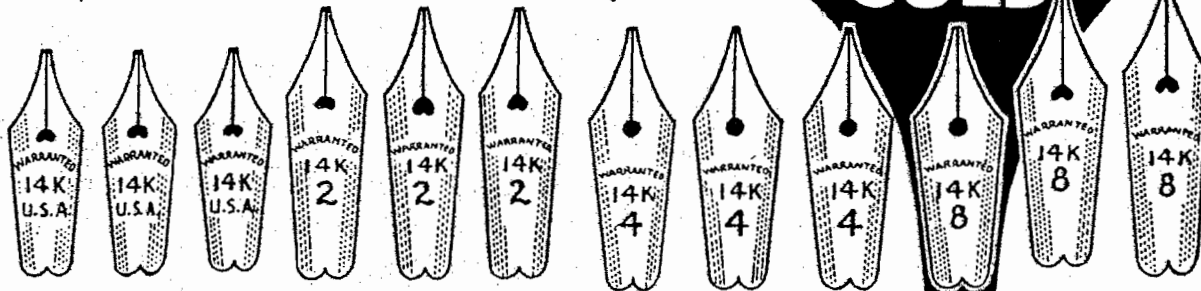

Alloy Iridium Tip Points 14K Gold

No. 19	Each 25c	Doz. \$3.00	No. 28	Each 45c	Doz. \$5.20
No. 21	Each 32c	Doz. 3.70	No. 31	Each 50c	Doz. 5.60
No. 23	Each 34c	Doz. 3.95	No. 32	Each 50c	Doz. 5.60
No. 24	Each 35c	Doz. 4.00	No. 50	Each 75c	Doz. 8.50

DURIUM PEN POINTS

A new point far superior to the gold-plated or plain steel point. Smooth writing, non-tarnishable Durium Pen Points will give complete satisfaction.

Sizes 2 and 4	40c doz.	Gross, \$3.20
Sizes 6, 7 and 8	45c doz.	Gross, \$3.50

Durium Two-Tone Nibs

4	50c doz.	\$4.20 gross
6 and 8	60c doz.	\$4.50 gross

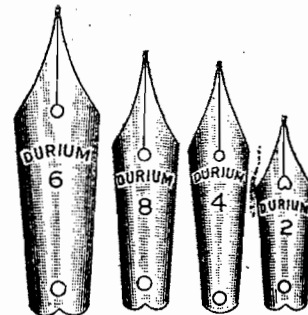

DRILL CHUCK



25c

POINT STRAIGHTENING PLIERS

Just the Right Size
Specially Ground
Made of Best Swedish Steel

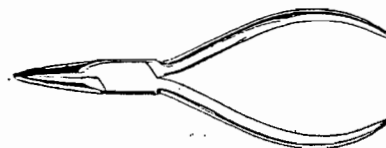

\$1.00 Each

DO YOUR OWN REPAIRING—ORDER A KIT NOW

STAINLESS STEEL BALL POINTED NIBS

Non-corrosive, stainless steel, gold-plated points
25c dozen \$2.45 gross

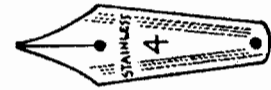

GOLD PLATED POINTS

Small points, dozen 15c Gross \$1.60
Large points, dozen 20c Gross 2.00



STAINLESS
CORROSION-PROOF

14K Gold Plated
F. P. Points
5c Each
45c Doz.
Gross \$4.40

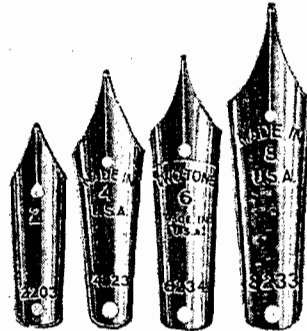

TWO-TONE



Dozen 55c
Gross \$5.00

RADIITE IRIIDIUM TIPPED POINTS

Made like the best quality gold nib highly-polished and non-tarnishable. These points will wear a lifetime.

Sizes 1 to 6 each 15c
Dozen \$1.50
Size 8 each 20c
Dozen \$1.90

RADIITE IRIIDIUM TIPPED TWO-TONE
GOLD PLATED NIB



Sizes 2—4—5
Each 18c
Dozen \$1.75

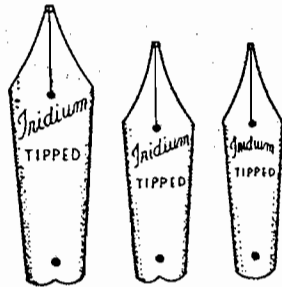

IRIDIUM TIPPED GOLD PLATED
SMOOTH WRITING NIBS

Each 12c
Dozen \$1.25
Gross 10.00



TWO-WAY BURNISHER
HARDENED STEEL
Highly Polished—Hard Rubber Handle
75c

POINT BURNISHING BLOCK

Made of Solid
Steel
None Better
for Straightening
Bent Points

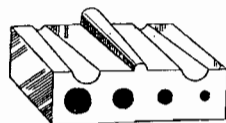

Each \$2.50
WITH TWO-WAY BURNISHER
\$3.00

PARKER VACUUM FILLER UNITS

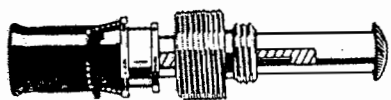

COMPLETE FILLER UNIT

SLENDER
STANDARD
OVERSIZE
40c Each



PARKER DUOFOLD CLIPS
SENIOR-JUNIOR-LADY
Each 25c
Dozen \$2.50

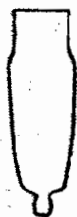

DIAPHRAGM FOR PARKER FILLER UNIT

SLENDER (Ladies)
STANDARD (Medium)
OVERSIZE (Large)

Each 10c
Doz. \$1.00

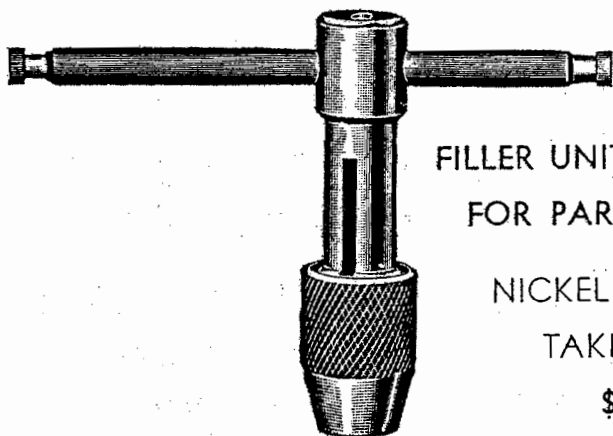

FILLER UNIT REMOVING TOOL
FOR PARKER VACUMATIC
NICKEL PLATED FINISH
TAKES ALL SIZES
\$1.00 Each

PARKER
DUOFOLD
BLIND CAPS
(End Caps)

SENIOR
JUNIOR
LADY



10c Each
\$1.00 Dozen

HAND VISE is used for holding small pieces of work. Die cast jaws—steel guide pin and screw—red enamelled wooden handle. A very useful tool.

75c

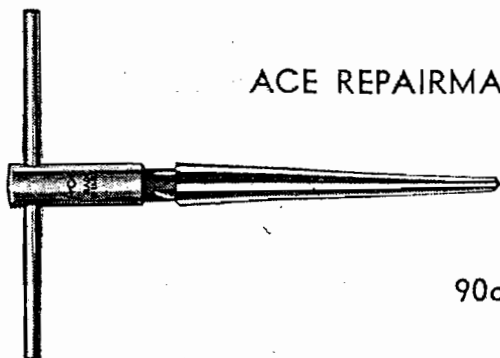

ACE REPAIRMAN'S REAMER

90c

Repairman's Reamer is a long-tapered reamer ranging from 1/8" diameter at the point to 1/2" diameter at the large end. Reamer is made of the highest grade of tool steel. It is indispensable wherever holes are made.

\$2.50 WILL BRING YOU ABOUT \$50.00 IN BUSINESS

IT PAYS TO
USE THE BEST

PenCraft

RUBBER SACS

ARE MADE OF
PURE GUM RUBBER

Guaranteed Not To
Swell From Acid Inks

Will Not Dry or Crack

Guaranteed Always Fresh

ACTUAL SIZE

No.



12S

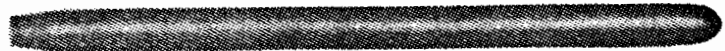

14EL

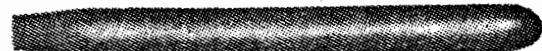

15S

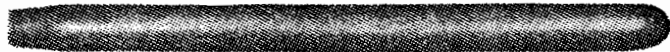

15L

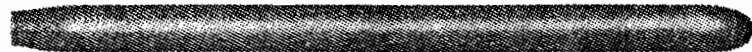

15EL



16L



16S



17EL



17S



18L



18S



18EL



19EL



20EL



20M



20S



22L



23M



23EL



23L



24EL

1 Dozen	\$.40
3 Dozen	1.00
100 Sacs	2.50
200 Sacs	4.50
300 Sacs	6.00
500 Sacs	8.00
1000 Sacs	12.00

2000 or over @\$10.00 per M

SAC HOOK

For
Removing Old Sac From

Barrel Each 10c
Doz. 75c



GIFT BOXES THAT HELP TO SELL—

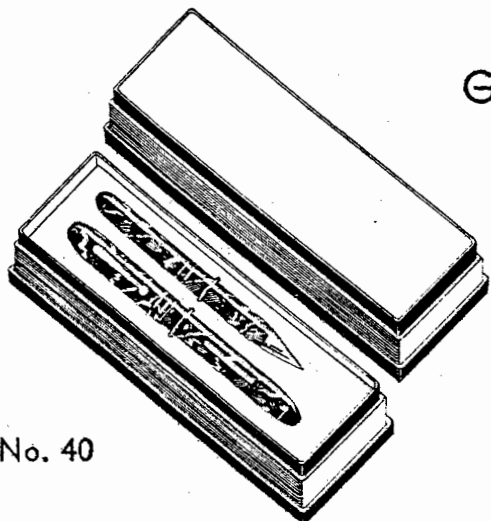

No. 40

DRESS UP YOUR PEN AND PENCIL SETS
WITH THESE ATTRACTIVE BOXES

20c Each \$2.25 Doz. \$23.50 Gross

Color—Ivory Bottom—Gold Covered Top

SILK LINED AND PADDED FOR EFFECTIVE DISPLAY
EVERY SET BOX HAS AN OUTSIDE PASTEBOARD COVER

No. 35 (at right) same as above Only for
Single Pen or Pencil

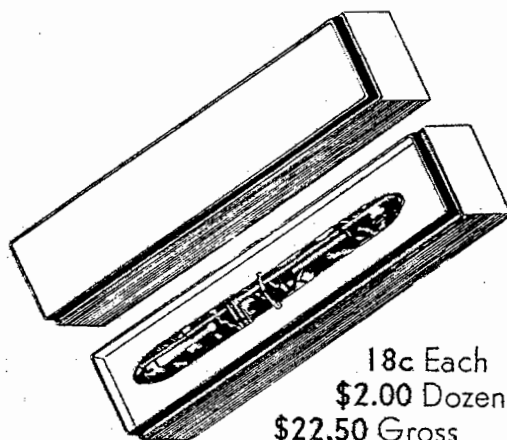

18c Each
\$2.00 Dozen
\$22.50 Gross

Can also be had in a Blue and Gold Combination—High Gloss Blue Finish Bottom—Gold Embossed Top—Imitation Plush Padding—Ribbon to hold Pen in place—Very distinctive.

STATUETTES—DESK SET ORNAMENTS

Supplied with Screw Prongs and Nut for Attachment to Base

Illustrations are 3/4 size



No. 1

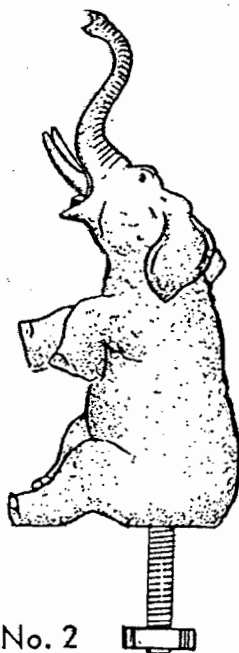

No. 2

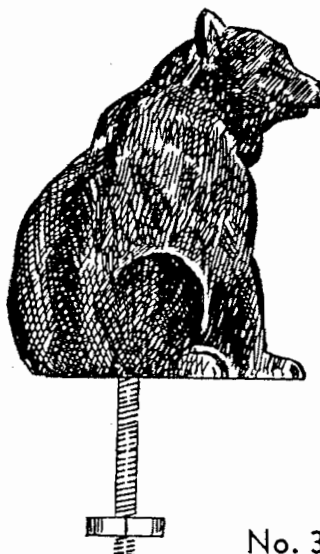

No. 3

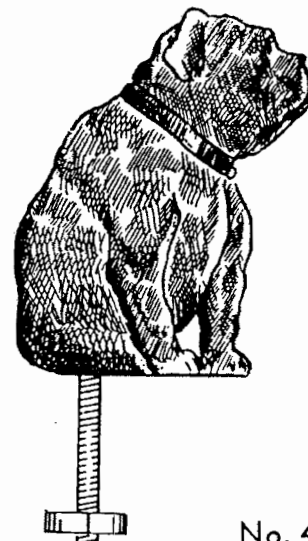

No. 4

IN PASTEL GREEN OR IMITATION BRONZE

Each \$.50

Dozen \$5.75

ON ANY MATTER PERTAINING TO FOUNTAIN PENS

INEXPENSIVE

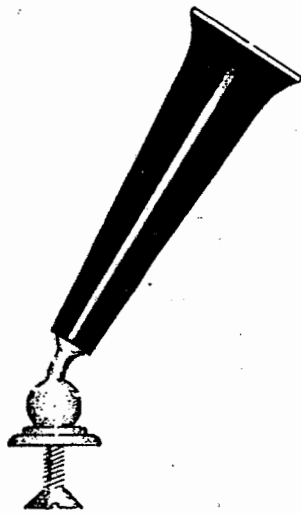

STATIONARY
GOOSENECK BRACKET
AND FUNNEL

Each\$.20
Dozen 1.80
Gross14.40

IN CHROME OR GOLD PLATED

INEXPENSIVE
DESK SET
FOUNTAIN PENS



	Each	Doz.	Gross
No. 12—With Durium Point	\$.22	\$2.25	\$21.00
No. 13—Durium Point and Band on Barrel25	2.40	22.50
No. 15—With 14 K Gold Point75	8.00	75.00

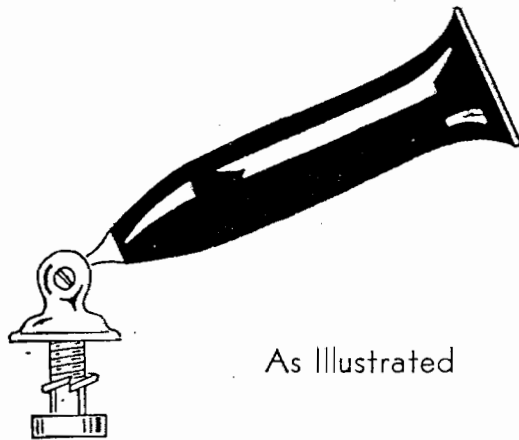

As Illustrated

PENCRAFT TWO-WAY SOCKET and
SWIVELS FOR DESK SETS

Gold Plated Swivel—Black Socket
60c each \$6.00 doz.
Chrome Swivel—Black Socket
50c each \$5.50 doz.

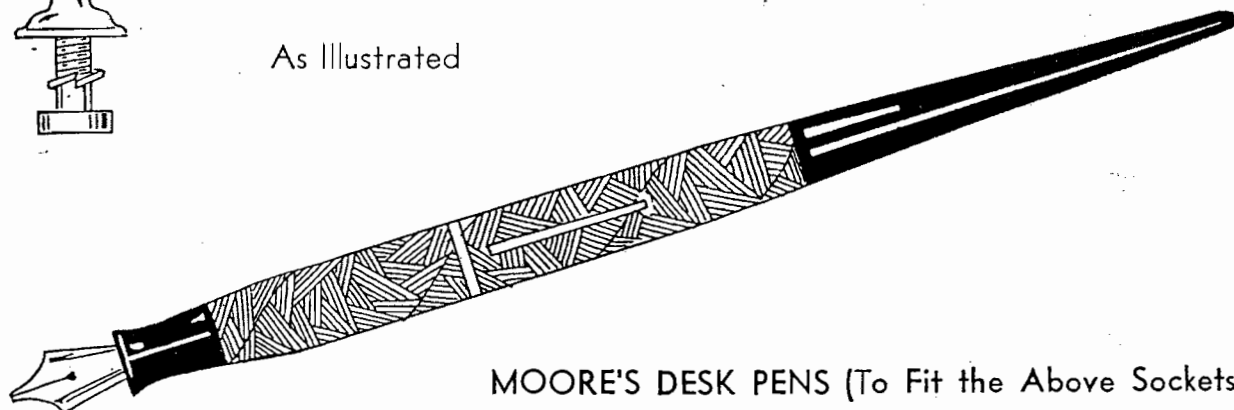

MOORE'S DESK PENS (To Fit the Above Sockets)

Beautifully Finished Holders with Solid Gold Nibs.....\$1.00 each \$10.80 doz.
Furnished in Black, Brown, Red, Marine Green and Mottled Grey

PENCRAFT, INC., 5 BROMFIELD STREET, BOSTON, MASS.

**WOOD CENTER
BRISTLE BRUSH WHEELS**

No.	Diameter	Price Each	Doz.
41G	2 1/2"	30c	\$3.00
42G	3"	35c	\$3.50

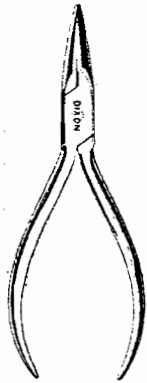
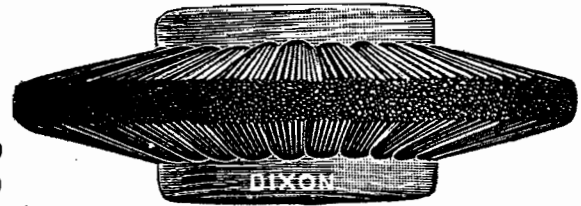

**POINT
STRAIGHTENING
PLIERS**

Just the Right Size
Specially Ground
Made of Best Swedish
Steel

\$1.00 Each

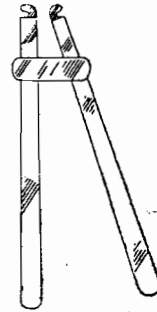

CLAMPS

To Fasten
Waterman
Levers

\$1.25 Each

TAPE COVERED PLIERS

For Removing Point Sections
Without Marring

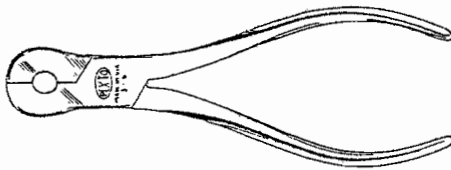

A Handy Tool for Many Uses

Price **\$1.25**

INNER CAP REMOVERS

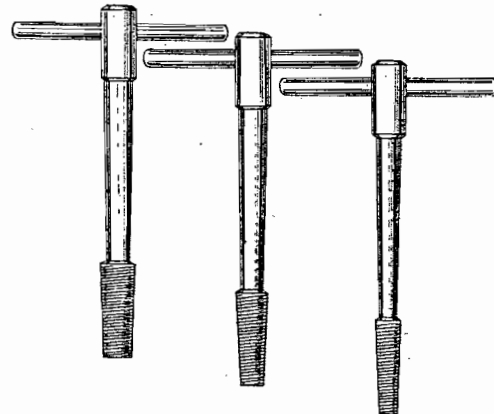

Will Remove Inner Caps with the
Least Amount of Breakage
No Shop is Complete Without a Set
Each **\$1.25** Set of Three **\$3.50**

SECURITY
Pen Clips Pencil

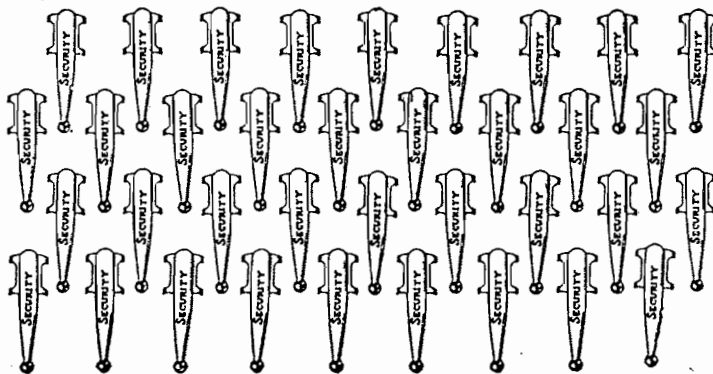

SLIP ON CLIPS

CARD
OF
3 DOZEN

\$1.20

GROSS **\$4.50**

SMALL SIZE FOR PENCILS
MEDIUM AND LARGE
FOR PENS

We Repair All Makes of
FOUNTAIN PENS—PENCILS
RONSON and EVANS LIGHTERS

WE RETURN ALL WORK SAME DAY RECEIVED

EVANS LIGHTER PARTS

No.		Each
1	Fuel Cap	\$.15
2	Flint Cap	.15
3	Flint Wheel	.30
4	Fulcrum Screw	.10
5	Case Spring	.10
6	Flint Spring	.10
7	Plunger Spring	.10
8	Plunger	.30
9	Snuffer Cap	.30

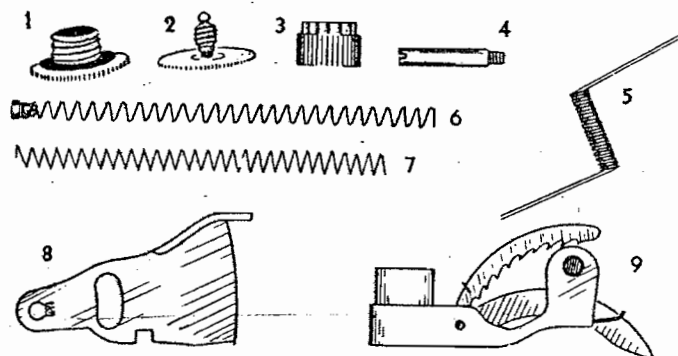

THE ABOVE PRICES ARE FOR LOOSE PARTS ONLY

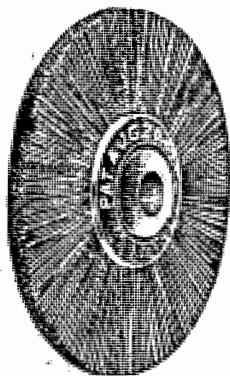

WIRE WHEEL BRUSHES
 NONE BETTER FOR
 POLISHING LIGHTER CASE
 OR CLEANING LIGHTER PARTS

- 3" Diameter 2 Row Str. Brass Wire.....60c Each
- 3" Diameter 3 Row Str. Brass Wire.....80c Each



BUFFING STICK

Good quality.....ea. 15c doz. \$1.50

GOLD ROUGE
 FOR USE ON BUFF STICK
 25c



WE OPERATE THE BEST EQUIPPED REPAIR SHOP.

No. 120 GRINDING OR POLISHING HEAD

Full Bronze Bearings

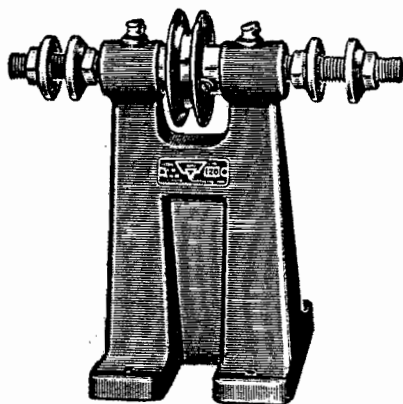

A stocky machine with a solid frame and ample base to withstand years of service. The spindle is $\frac{1}{2}$ inch in diameter and runs in two bronze bearings $\frac{1}{4}$ inches long. It is wick-oiled from two large reservoirs in the casting just below the bearing on either side which are fed through the spring top oilers.

The spindle is threaded at both ends and carries two sets of hardened flanges $1\frac{1}{4}$ inches in diameter to carry wheels up to 4 inches in diameter with a $\frac{3}{4}$ -inch face and $\frac{1}{2}$ -inch hole. The V-belt pulley is $2\frac{1}{4}$ inches in diameter. Designed to drive from above, behind or below.

Frame nicely finished in battleship gray. Flanges polished, nicked and buffed.

Height	Base	Weight	Price Each
6 inches	$4\frac{1}{8} \times 4\frac{1}{8}$ inches	$5\frac{1}{4}$ lbs.	\$2.75
	Add Postage		

No. 125 GRINDING OR POLISHING HEAD

Full Bronze Bearings

Exactly the same as No. 120 above, but fitted with a clean, deep taper thread spindle in place of the wheel arbor on the left. This permits the use of buffing wheels and a great variety of wheels built on wood centers, and on the right an all-steel three-jawed chuck, that holds rods or drills from 0 to $\frac{3}{8}$ inch in diameter. Height given is to center of spindle.

Height	Base	Weight	Price Each
6 inches	$4\frac{1}{8} \times 4\frac{1}{8}$ inches	5 lbs.	\$3.30
	Add Postage		

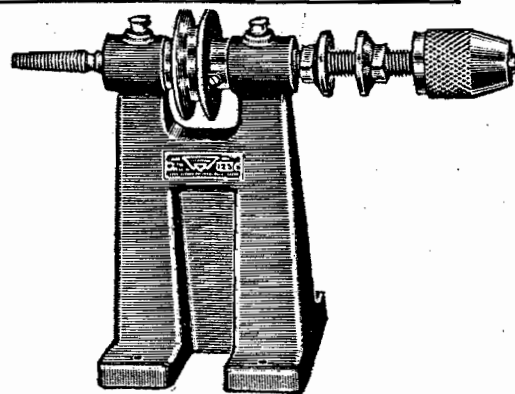

No. 130 GRINDING OR POLISHING HEAD

Full Bronze Bearings

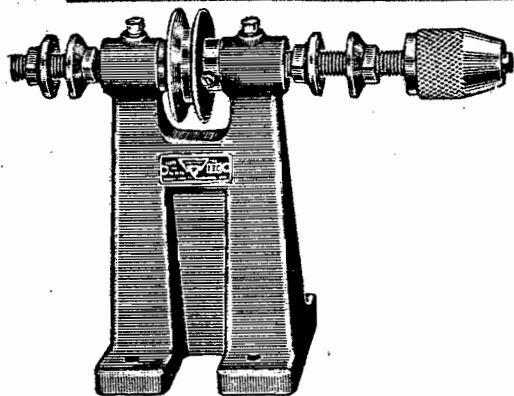

Exactly the same as No. 120 above, but with a longer spindle on the right side on which is a nicked and buffed all-steel chuck with three hardened jaws that holds 0 to $\frac{3}{8}$ inch round shank drills or rods.

Height	Base	Weight	Price Each
6 inches	$4\frac{1}{8} \times 4\frac{1}{8}$ inches	$5\frac{1}{2}$ lbs.	\$3.50
	Add Postage		

No. 155 POLISHING HEAD

"Oilite" Bronze Bearings

A heavier head with bigger base, greater height, running in two "Oilite" bronze bearings. The spindle is $\frac{3}{4}$ inch in diameter and carries a deep, clean taper thread and a pair of wheel flanges on one end and a pair of flanges and chuck on the other.

The wheel flanges are $1\frac{3}{4}$ inches in diameter and hold wheels up to 6 inches or larger in diameter with 1-inch face and $\frac{1}{2}$ -inch hole. Hardened steel flange nut. The chuck has three hardened steel jaws and holds 0 to $\frac{3}{8}$ inch drills or rods. Polished V-belt pulley is $2\frac{1}{4}$ inches in diameter and drives from above, behind or below.

Frame finished in battleship gray enamel. Flanges and chuck nickel plated and buffed.

Height	Base	Weight	Price Each
$7\frac{1}{2}$ inches	5 x 5 inches	9 lbs.	\$7.15
	Add Postage		

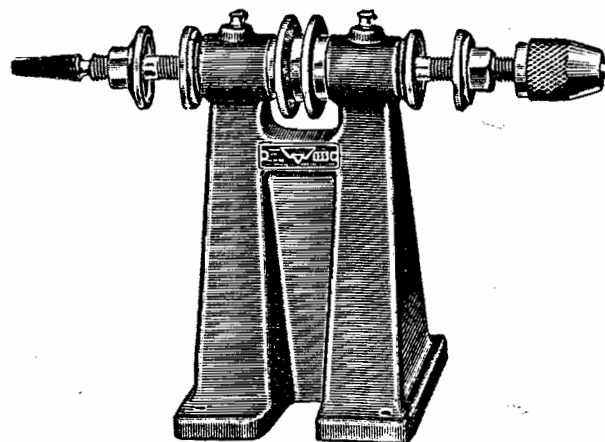

No. 501 M-S POLISHING HEAD

A big value in a small machine. The 1/2-inch spindle is equipped with two sets of flanges for holding wheels up to 3/4 inch wide with 1/2-inch holes, also a three-jawed chuck for holding round shanks up to 1/4 inch in diameter. Pulley with two grooves for V belt is 1 3/4 inches in diameter. Oil holes with brass plugs provided. Base black and pulley red enameled.

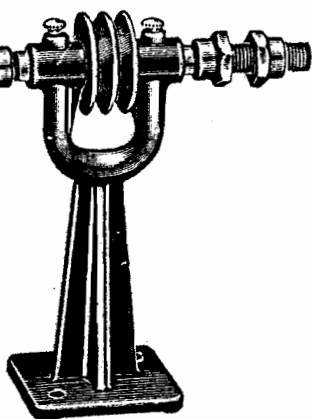

Height
6 3/4 inches

Weight
2 1/4 lbs.
Add Postage

Price Each
\$1.70

No. 15 M-S VISE

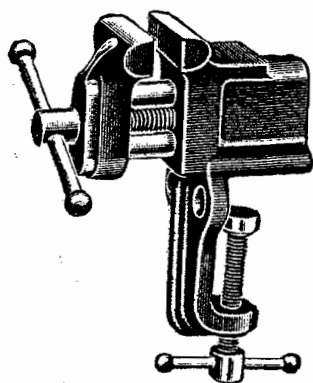

A small vise of the well known twin guide rod construction which, with the clean cut screw, gives smooth action and rigidity. Jaws meet squarely. Clamps to bench up to 2 inches thick. Machined jaws 1 1/2 inches wide. Body casting finished in red and movable jaw casting in black enamel.

Jaws Weight Price Each
1 1/2 inches 2 1/8 lbs. \$1.00
Add Postage

No. 1700 M-S VISE

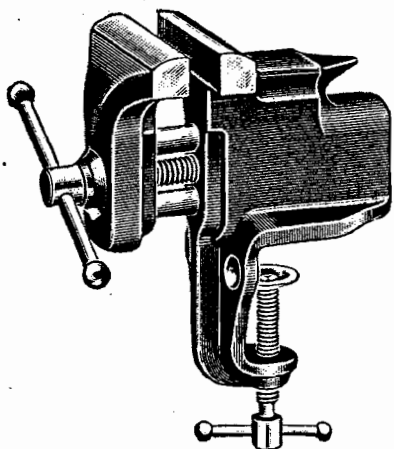

A strong, rigid vise with machined jaws 2 1/2 inches wide that open 2 1/4 inches. Jaws meet squarely. Twin steel guide rod construction. Small anvil on body casting. Body finished in red, movable jaw in black enamel. Clamps to bench up to 2 inches thick.

Jaws Weight Price Each
2 1/2 inches 3 1/2 lbs. \$1.40
Add Postage

CANTON FLANNEL POLISHING BUFFS

Machine Sewed

3" Diam. 30 Ply 3 Rs. 25c ea. \$2.30 doz.
4" Diam. 30 Ply 3 Rs. 30c ea. \$2.60 doz.
5" Diam. 30 Ply 3 Rs. 35c ea. \$3.40 doz.

CARBORUNDUM WHEELS

With Lead Centers

For General Grinding Work,
Tools, Parts, Fittings, etc.

3" Diam. x 3/8" thick. . 75c ea.
4" Diam. x 1/2" thick. . \$1.25 ea.



LEAD CENTER MUSLIN
POLISHING BUFFS

3" Diam. 54 Ply
35c ea. \$3.55 doz.
4" Diam. 54 Ply
40c ea. \$4.15 doz.
5" Diam. 54 Ply
50c ea. \$5.40 doz.

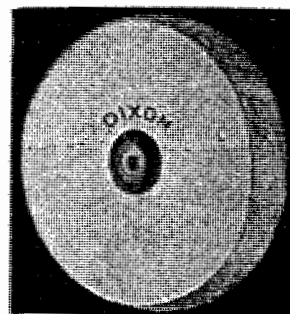

MUSLIN POLISHING BUFFS
Machine Sewed

3" Diam 35 Ply
15c ea. \$1.40 doz.
4" Diam. 42 Ply
20c ea. \$1.80 doz.
5" Diam. 45 Ply
25c ea. \$2.50 doz.

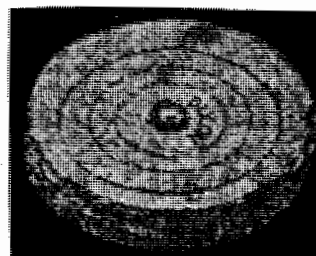

WAHL-EVERSHARP FINE

PACEMAKER

Pen is equipped with a 14K solid gold, iridium tipped point for permanent velvety smooth writing.

Has a dependable lever-vac filling mechanism—ink window shows when to refill. Constructed in beautiful colors of genuine unbreakable pyralin with gold filled banding and modern clip.

This new pen has been perfectly matched with the new Eversharp Repeating Pencil—the pencil you can sharpen with your thumb!

Press the top and a new point appears! Where one lead is used, you don't have to refill. Just press the top—and a new lead takes the place of the one you have used! Feeds leads continuously—needs refilling only once or twice a year.

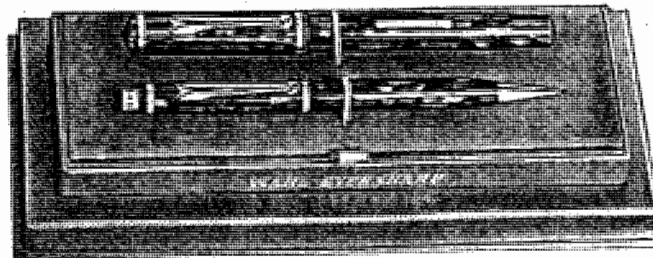
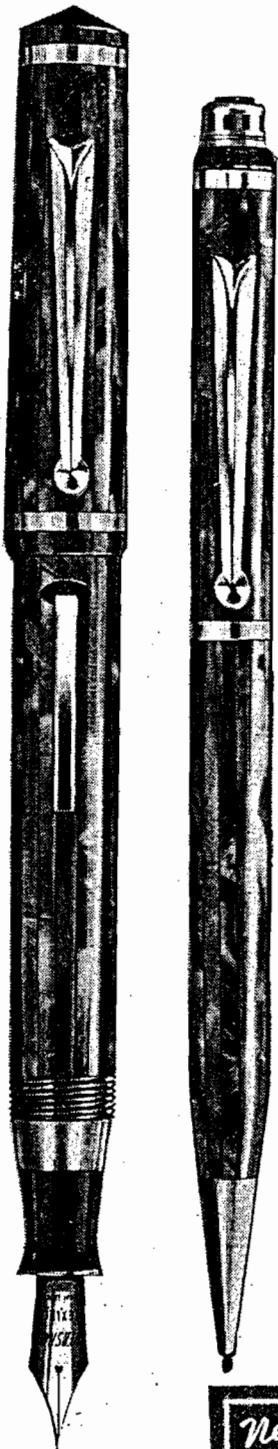

REGULAR MODELS

Pen		Pencil
\$3.50		\$2.00
02510.....	Jet Black.....	10810
02511.....	Green Satin.....	10811
02512.....	Red Satin.....	10812
02514.....	Gold Satin.....	10814

SLENDER MODELS

Pen		Pencil
\$3.50		\$2.00
02410.....	Jet Black.....	10810
02411.....	Green Satin.....	10811
02412.....	Red Satin.....	10812
02414.....	Gold Satin.....	10814

Pens \$3.50—\$2.10 Net

Pencils \$2.00—\$1.20 Net

Special ensemble set price \$5.00—\$3.00 Net

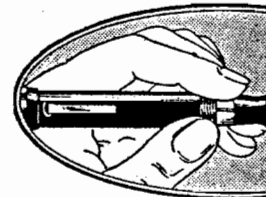

WAHL OXFORD SET

Select-O-Point pens are available in points—Points gold-plated, iridium tip

Not only is there point selection but that the points are replaceable—snap insert the new.

Constructed in beautiful colors of Equipped with an efficient lever-vac shows when to refill.

Matching pencil has propel, repel, e for Eversharp Square Lead—lead can't

Pens	Colors
22110.....	Jet Black
22114.....	Brown Sw
22118.....	Green Sw
Pens \$1.00	Pencils \$.65

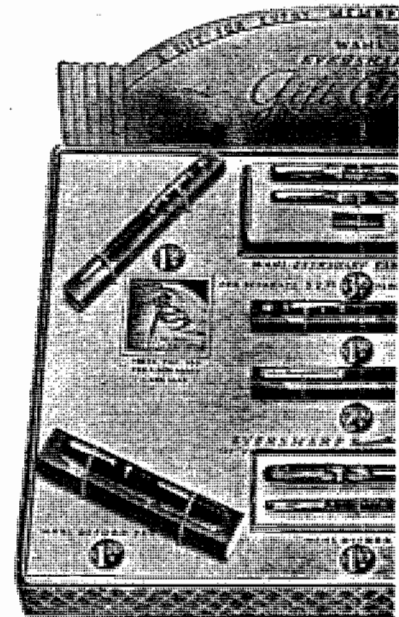

GIFT CHEST A

For the first time the Wahl Company offers you a priced from \$1.00 to \$3.95. This gift chest gives business but also on pen and pencil gift business.

ASSC

- 1—Eversharp Repeating Pencil No. 10610 or No. 10611
 - 3—Eversharp Repeating Pencils No. 13100, No. 13101, No. 13102
 - 2—Wahl Oxford Pens, No. 22110 and No. 22114 at \$1.00
 - 1—Wahl Oxford Set, No. 22118—20118 at \$1.65
 - 1—Wahl-Eversharp Varsity Set with 15c tube of lead
- Retail Value \$14.10

Dea

THE PENCIL YOU CAN

The aristocrat of display cards—attractively colored in Black and Gold with a wine colored suede pencil pad—is offered FREE with No. RP-6 Assortment.

No. RP-6 ASSORTMENT—6 \$2.00 Repeating pencils—rhodium and black pyralin—mounted on an attractive display card. Necessary boxes FREE.

Retail Price\$12.00
Dealer Cost \$7.20 Dealer Profit \$4.80

New WAHL
EVERSHARP
REPEATING PENCIL

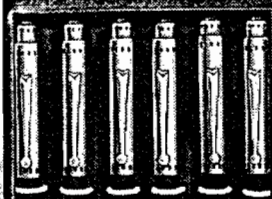

Fills in half a minute—Just drop the leads in the top

\$2.00

Just press the top—leads leads continuously

THE PENCIL YOU CAN SHARPEN WITH YOUR THUMB!

WRITING INSTRUMENTS

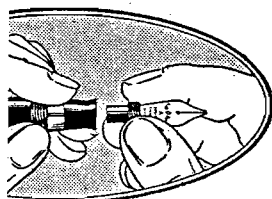

SELECT-O-POINT

Available with four types of replaceable iridium tipped for smooth, easy writing. Attention but a big feature of this pen is—simply screw out the old point and

colors of genuine unbreakable pyralin. lever-vac filling mechanism. Ink window

repel, expel mechanism. Square tipped ad can't slip, twist, or turn.

Colors Pencils
 Jet Black 20110
 Brown Swirl 20114
 Green Swirl 20118
\$.65 Sets \$1.65—Cost 99c



VARSIITY

A New Wahl-Eversharp Pen constructed in beautiful new colors of unbreakable pearl pyralin. Attractive banding and modern clips add to distinction of merchandise. 14K solid gold, iridium tipped points assure smooth, easy writing. Has dependable lever-vac filling mechanism—ink window shows when to refill.

Matching pencils have propel, repel, expel mechanisms—square tipped for Eversharp Square Lead—lead can't slip, twist, or turn.

Take advantage of the special combination sets. A pen with a perfectly matched pencil and a tube of Eversharp Square Lead packed in an attractive gift box . . . and what's more the retail price is less than that for the pen and pencil.

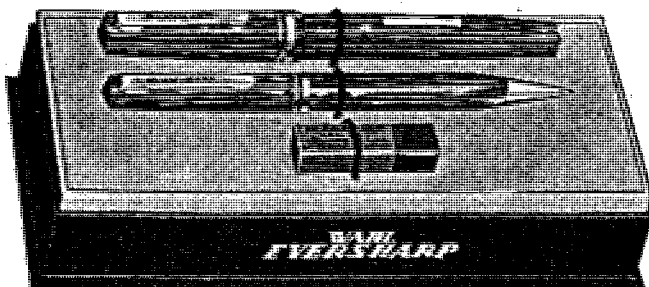

List	Pen	Pencil	Set \$3.95 with Free tube lead
Jet Black	02300	00300	92300
Green Panelled with Red and Silver ..	02301	00301	92301
Red Panelled with Black and Silver ..	02302	00302	92302
Gold Panelled with Black and Gold ..	02304	00304	92304

Pens \$2.75—\$1.65 Net
Pencils \$1.50—90c Net

Special ensemble with free tube of lead \$3.95—\$2.37 Net

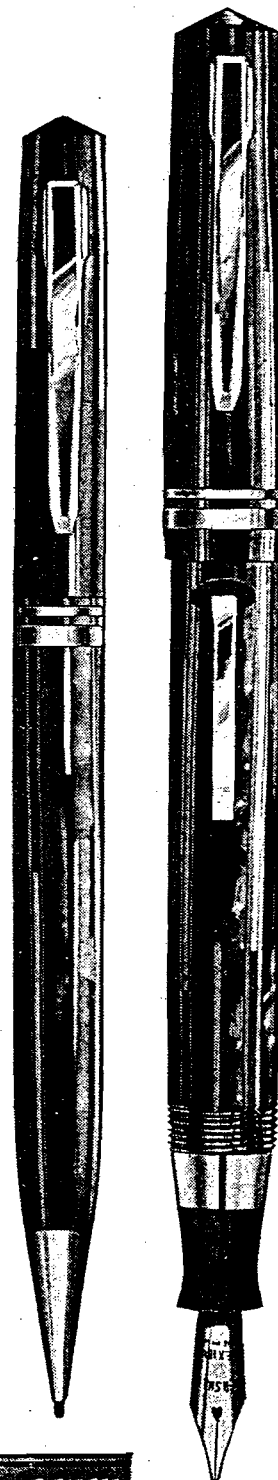

BEST ASSORTMENT

you a new gift chest of nationally advertised, fast-selling pens and pencils that gives you the opportunity to not only cash in on the Christmas gift business, all year around. Each item packed in an attractive gift box.

ASSORTMENT X-38

No. 10645 at \$2.00	\$2.00	\$1.20
No. 1101, No. 13102 at \$1.50 each	4.50	2.70
2114 at \$1.00 each	2.00	1.20
1.65	1.65	.99
of lead at \$3.95 (assorted colors—our option)	3.95	2.37
Dealer Cost \$8.46		Dealer Profit \$5.64

CAN SHARPEN WITH YOUR THUMB



RP-15 ASSORTMENT—12 genuine \$1.50 Eversharp Repeating Pencils in three attractive colors—red, green, and black. Distinctive banding and a modern clip add to attractiveness of merchandise. Entire assortment mounted on a display card that dramatically tells the story of this new pencil—ties in with National Advertising.

New Eversharp Repeating PENCIL

BE SURE IT'S A GENUINE EVERSHARP

The Pencil being used by busy people everywhere

MADE ONLY BY THE WAHL COMPANY

THE PENCIL YOU CAN SHARPEN WITH YOUR THUMB!

\$1.50

E-Z-C PRICE TICKETS

NEAT — ATTRACTIVE — NON-TARNISHABLE
UNBREAKABLE — EASY TO READ — STAY CLEAN

(NOT MADE OF PAPER OR CARDBOARD)

#595 E-Z-C PRICE TICKETS

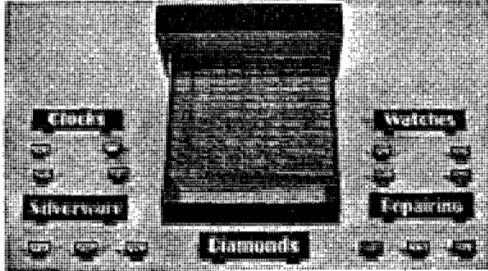

\$3375

← ACTUAL SIZE

(Silver on black)

- 540 PRICE TICKETS
5 each 25c to \$400.
- 5 SIGNS
- 75 EASELS

\$595

Complete with Box

- Additional Price Tickets
- Any Denomination from 1c up
- No less than 10 of one denomination
10 for 35c
- Additional Easels—Single slot
50 for \$1.00

- 75 UNBREAKABLE EASELS
- 5 NEAT DISPLAY SIGNS
- 540 PRICE TICKETS
- 108 DIFFERENT DENOMINATIONS

5 of each as follows

25c	3.95	8.00	15.50	37.50	85.00
50c	4.00	8.50	16.50	39.75	87.50
75c	4.25	8.75	16.95	40.00	90.00
95c	4.50	8.95	17.50	42.50	95.00
1.00	4.75	9.00	18.50	45.00	99.75
1.25	4.95	9.50	19.50	47.50	100.00
1.50	5.00	9.75	20.00	49.75	125.00
1.75	5.50	9.95	21.50	50.00	150.00
1.95	5.75	10.00	22.50	52.50	175.00
2.00	5.95	10.50	24.50	55.00	195.00
2.25	6.00	11.50	24.75	57.50	200.00
2.50	6.50	12.50	25.00	60.00	225.00
2.75	6.75	12.75	27.50	62.50	250.00
2.95	6.95	12.95	29.75	65.00	275.00
3.00	7.00	13.50	30.00	67.50	300.00
3.25	7.50	14.50	32.50	70.00	350.00
3.50	7.75	14.95	33.75	75.00	375.00
3.75	7.95	15.00	35.00	77.50	400.00

SECTIONS MARKED
FOR QUICK SELECTION

E-Z-C SIGN TICKETS

50 DOUBLE SLOT EASELS
234 SIGN TICKETS

Additional Easels—Double Slot
50 for \$1.00

Additional Sign Tickets (no less than
10 of each sign)—10 for 35c

#295 E-Z-C SIGN TICKETS



AS USED
WITH
PRICE
TICKET →



(Silver on black)

- 50 EASELS
- 234 SIGN TICKETS AS LISTED

Diamond
Jeweled
15 Jewels
17 Jewels
19 Jewels
21 Jewels
23 Jewels
10K Gold
14K Gold

18K Gold
Sterling
Platinum
Gold Filled
Special
Charge It
Pay Weekly
Easy Terms
Real Value

\$295

Complete with Box

Now, you'll enjoy writing MORE, with the QUALITY PEN that gives a thought to your pocketbook!



PROVES THAT YOU CAN GET A REALLY GOOD FOUNTAIN PEN FOR A DOLLAR

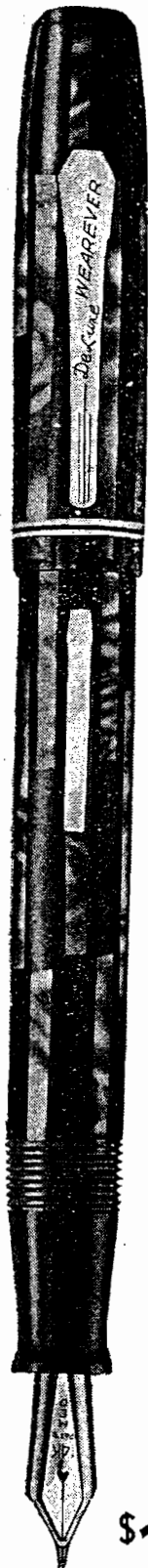

Compares with any on the market in beauty, utility, wear and value.

- 14 Carat Gold Reinforced Point (Fine Medium, Broad)
- Large Ink Capacity
- Vacuum Sealed, Leak Proof Cap
- Instant Flow Feed
- Choice of gorgeous inlay effect colors—Pearl Black, Copper Black, Green Black
- Men's and Women's Sizes

And the price is only \$1.00

WEAREVER OFFERS

A Gift Set For Everybody

\$1.00



\$1.50

WEAREVER DE LUXE PEN AND PENCIL SET Dealers cost \$1.00 Each \$10.80 Doz.

Here is the fine Wearever DeLuxe Pen put up with a companion pencil in a handsome gift package for yourself and your friends. The propel, repel, expel pencil matches the pen in every way for quality and value. It holds a yard of lead, has a concealed eraser and its trim is gold plated. Alone, the pencil sells for 50c. but with the pen it makes a combination that can't be beat for only \$1.50. A Set You'll Be Proud To Give

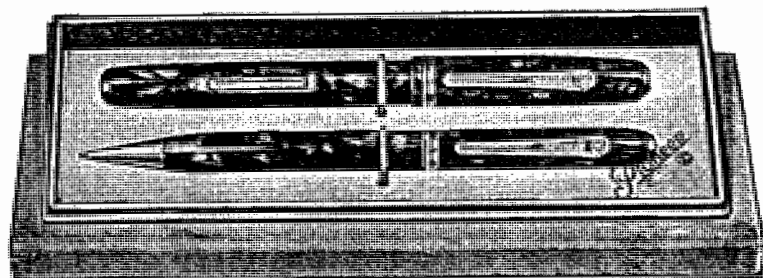

\$1.00

For quality at a popular price you will hunt a long time for the equal of this Wearever-made Fountain Pen and Pencil Set. Its beautiful Pearl colors offer a choice of morocco, blue, green, grey or black. The pen has a 14 Kt. gold reinforced point, narrow chased band, gold plated trim. The pencil to match uses 4 inch leads and has a triple action movement. Put up in an attractive gift box.

Dealer Cost 65c Each—\$7.20 Doz.

SALES PRODUCING EASEL ASSORTMENTS BY PARKER

Genuine PARKER quality

With super-smooth nibs and points

Smartly styled

With non-breakable barrels

All pens with Visometer feature—shows when to refill



Parkette Pen Easel No. 378

Size: 13 x 12 1/2"

Displays pens in writing position, emphasizing Visometer feature

12 Parkette Pens at \$1.25

Total list—\$15.00

Dealer cost—\$9.00

Parkette Set Deal No. 339

Complete Duette set department

Parker pen and pencil sets to suit all persons and purses

Easel lithographed in three brilliant colors and "Lamcote" finished. Size 21 x 23", suitable for window or counter display.

Deal 339 Consists of:

2 Parkette Sets	\$1.95	\$3.90
2 Parkette DeLuxe Sets	2.95	5.90
2 Challenger Sets	3.95	7.90
2 DeLuxe Challenger Sets ..	5.00	10.00
2 Royal Challenger Sets	7.50	15.00
		<hr/>
Total List		\$42.70
Dealer Cost		25.62
Dealer Profit		17.08

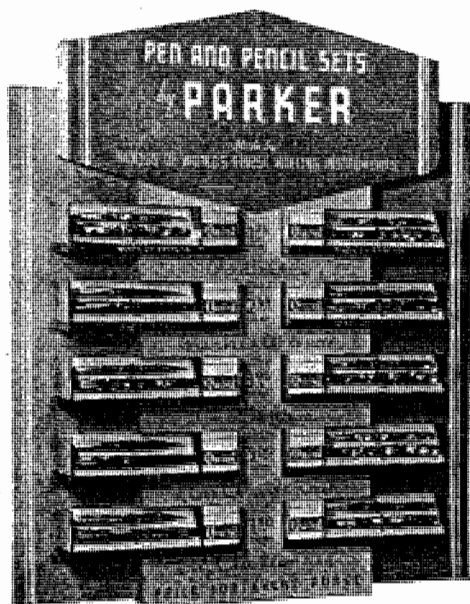

PARKER DESK BASES—\$1.95 to \$5.00—DISCOUNT—40%

SEND FOR DESCRIPTIVE FOLDER

Parker

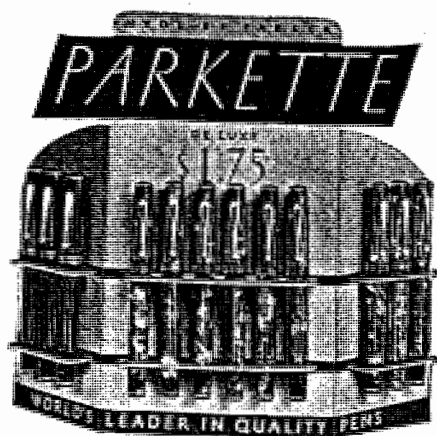

Parkette DeLuxe Pen Easel No. 979

Size: 10 x 11"

Displaying attractively:

12 Parkette DeLuxe Pens at \$1.75
 Total List \$21.00
 Dealer Cost .. 12.60

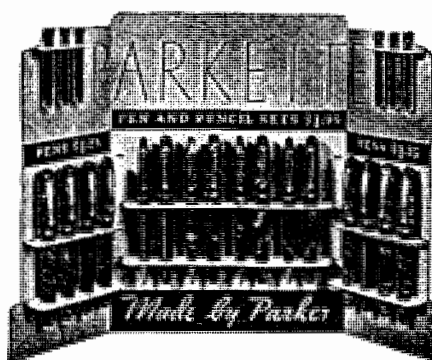

Parkette Combination Easel No. 983

Size: 16 x 10" Features Parkette Pens and Sets with free lead cartridges

8 Pens @ \$1.25 \$10.00
 4 Sets @ \$1.95 7.80
 6 Lead Cartridges @ 15c. ... FREE
 Total List \$17.80
 Dealer Cost 10.68



Parkette Pen and Set Com- bination Easel No. 980

Size: 17 x 19"

Features Parkette and Parkette DeLuxe Pens and Sets

4 Pens @ \$1.25 \$5.00
 4 Pens @ \$1.75 7.00
 2 Sets @ \$1.95 3.90
 2 Sets @ \$2.95 5.90
 Total List \$21.80
 Dealer Cost 13.08

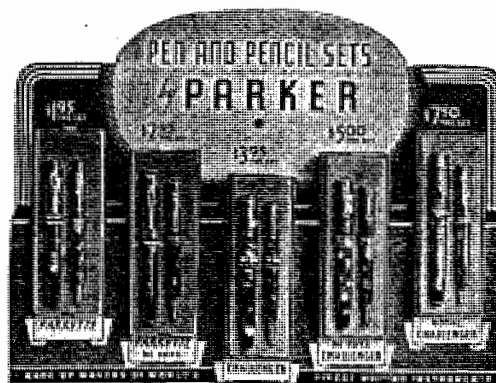

Easel No. 327

Size: 16 1/4 x 12 1/4"

An attractive but complete display for sets

1 Parkette Set \$1.95
 1 Parkette DeLuxe Set 2.95
 1 Challenger Set 3.95
 1 DeLuxe Challenger Set ... 5.00
 1 Royal Challenger Set 7.50
 Total List \$21.35
 Dealer Cost 12.81

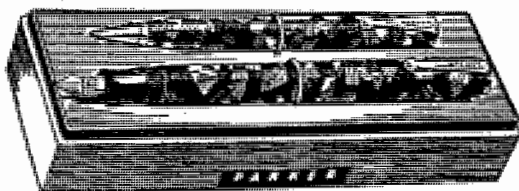

PARKER CHALLENGER

	List	Dealer Cost
PEN	\$2.75	\$1.65
PENCIL	1.25	.75
SET	3.95	2.37

CHALLENGER DE LUXE

PEN	\$3.50	\$2.10
PENCIL	1.50	.90
SET	5.00	3.00

Moore's SPEEDLINE FOUNTAIN PEN

SOLD TO THE BEST TRADE SINCE 1900

Fitted with the famous smooth-writing MANIFLEX POINT, these stylish models offer the utmost in attractiveness.

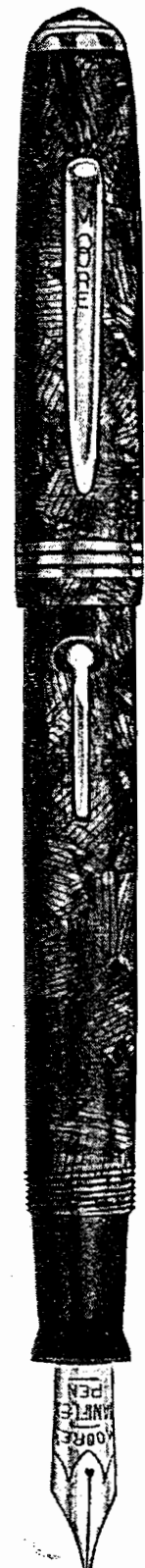

Short clip		Retail Price	Dealer Cost
No. 282C	Black	\$3.00	\$1.80
283C	Gray	3.00	1.80
284C	Brown	3.00	1.80
285C	Green	3.00	1.80

Long Clip		Retail Price	Dealer Cost
No. 292C	Black	\$3.00	\$1.80
293C	Gray	3.00	1.80
294C	Brown	3.00	1.80
295C	Green	3.00	1.80

Standard Models		Retail Price	Dealer Cost
No. 492C	Black	\$5.00	\$3.00
493C	Gray	5.00	3.00
494C	Brown	5.00	3.00
495C	Green	5.00	3.00

Oversize Models		Retail Price	Dealer Cost
No. 692C	Black	\$7.50	\$4.50
693C	Gray	7.50	4.50
694C	Brown	7.50	4.50
695C	Green	7.50	4.50

PEN AND PENCIL SETS

No. 283C Ladies'	No. 2828	Short—Black	\$5.00	\$3.00
	No. 2929	Long—Black	5.00	3.00
	No. 4929	Long—Black	7.50	4.50
	No. 6929	Oversize—Black	10.00	6.00

No. 493C
Men's

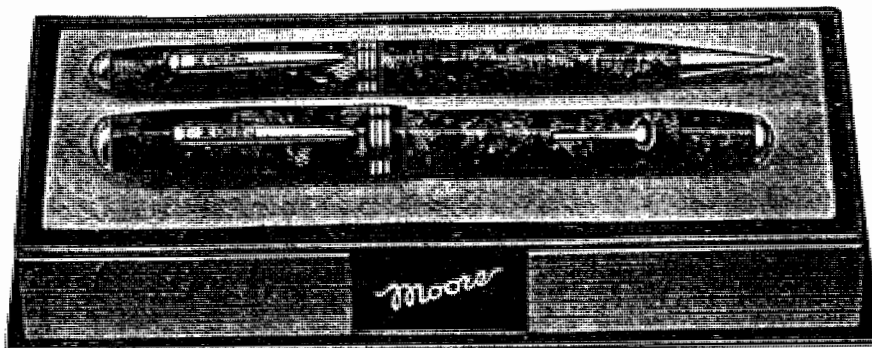

SPECIFY
COLOR

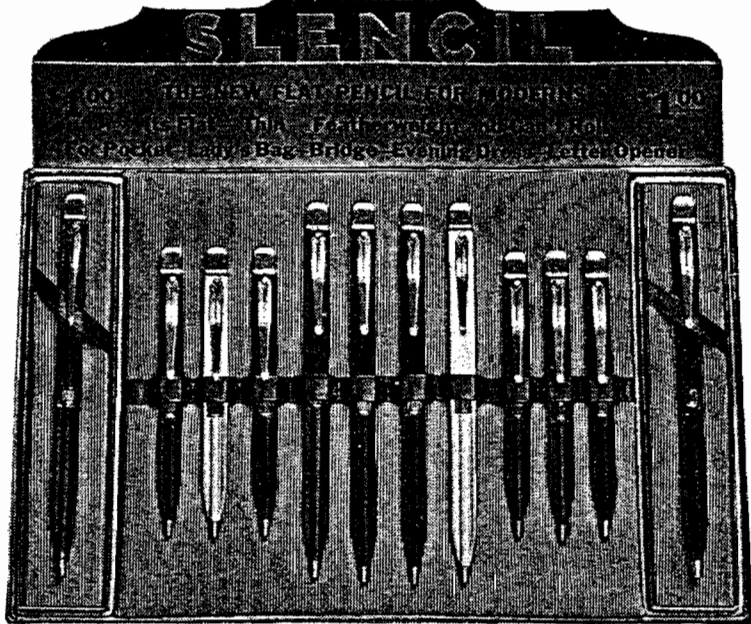

Slencil Assortment—consists of 12 Slencils
 6 long, 6 short mounted on silk easel pad
 12 gift boxes supplied with the assortment
 Assorted colors, Black, White, Green, Blue, Red and Gold Bronze
 No. 100 Slencil retails for \$1.00—65c net
 No. 100 Slencil Assortment retails for \$12.00—\$7.50 net

BOOKMARK PENCIL WITH NOTE BOOK

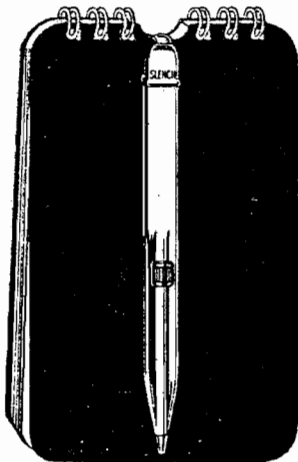

Slencil serves as a bookmark. Perfectly balanced, is flat so it will not roll nor bulge in pocket or purse. Choice of colors and two lengths—Slencil Note Book Assortment—consists of 12 Slencils and Note Books, packed in attractive counter display carton.

No. 125 Note Book Combination
 Retail \$1.25—75c net
 Assortment of 12
 Retail \$15.00—\$9.00 net

PEN AND PENCIL SET

Choice of Colors, Black, Brown, Green, Gray

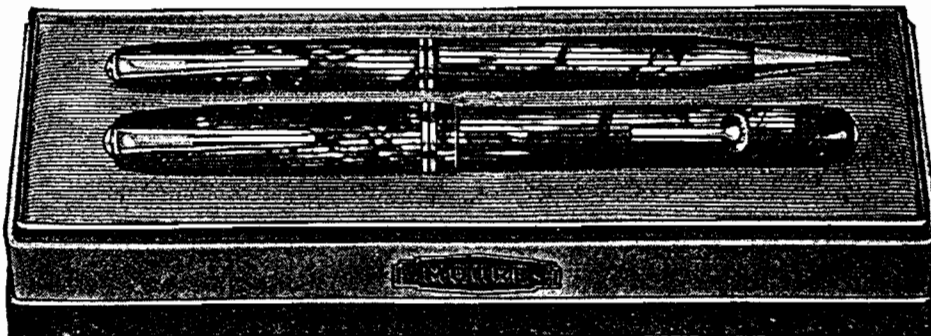

The MOORE

**"MASTERCRAFT"
 FOUNTAIN PENS**

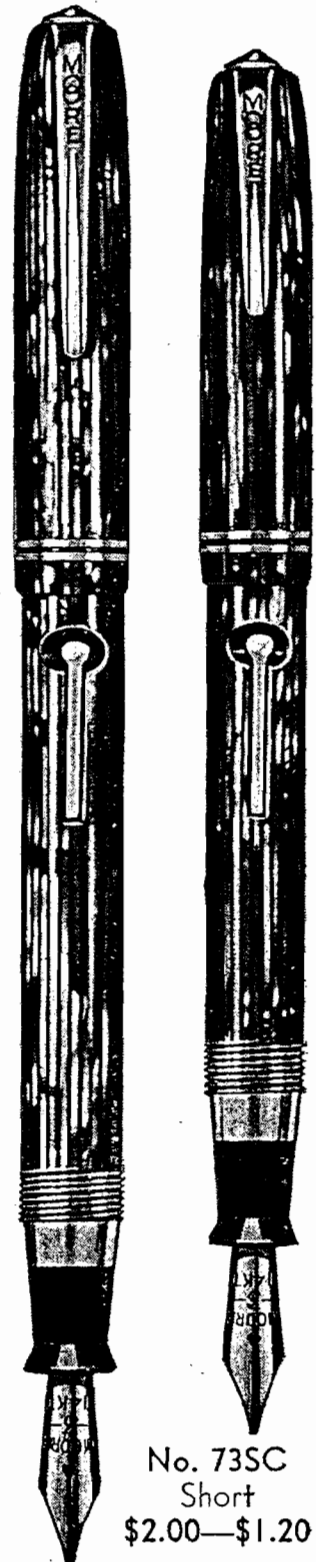

No. 73SC
 Short
 \$2.00—\$1.20

No. 73LC
 Long
 \$2.00—\$1.20

Choice of Colors
 Black, Brown, Green
 Gray

The WASP

DIVISION OF SHEAFFER PEN

Clipper

STANDARD OF QUALITY IN THE POPULAR PRICED FIELD—

Nationally Advertised in 4 Colors. You Have Seen WASP CLIPPERS Advertised in COLLIER'S, SATURDAY EVENING POST, LIBERTY and METROPOLITAN NEWSPAPERS.



TODAY'S FINEST LOW-PRICED PEN AND PENCIL VALUES

Give your customers pen sets with GENUINE GOLD POINTS. Cheap steel points, gold plated, which will not give equal service, are used in many pens at even higher prices. Attractive Counter Salesman displays four sets with space in back to hold two in reserve. Dependable WASP CLIPPER lever fillers, delightful colors, GENUINE GOLD POINTS iridium-tipped; each box marked "Division of Sheaffer Pen." Good values for customers; good profit items for you!

Order No. 702 Assortment

6 WASP CLIPPER SETS — RETAIL \$1.95 Each

6 WASP CLIPPER Sets. Assorted Colors (Black, Silver Lahn, Brown Lahn, Green Lahn, Gray and Green). Each set complete with \$1.25 Pen, \$1.00 Pencil to match and Sample Skrip, at \$1.17.....\$7.02

6 Display Boxes.....FREE
1 Counter Salesman.....FREE

Retail \$11.70 — Net to You \$7.02 — Profit \$4.68



No. 900
Card Assortment

NO. 900 CARD ASSORTMENT

1 Dozen cards of real value \$1.25 pens. WASP CLIPPER lever type. Each fitted with genuine gold point, tipped with iridium. Pens assorted in Black, Gray, Green, Silver Lahn, Brown Lahn and Green Lahn. Total Retail Value, \$15.00. \$9.00 each net — in lots of 3, \$8.65 each net — 12 or more cards, \$7.50 each net.

NEW *Convertible* PEN & PENCIL SET



The perfect full ink capacity
Pen

The perfect Pencil

For your Purse . . .

For your vestpocket

By simple interlocking of ends
convertible into PEN-PENCIL
combination

You choose the Style

SET
RETAIL

\$1.00 each

DEALER COST

\$7.50 doz.

for...

Rugs, Clothing,
Paper, Linens,
Etc.

\$1.00 doz.

\$9.00 gross



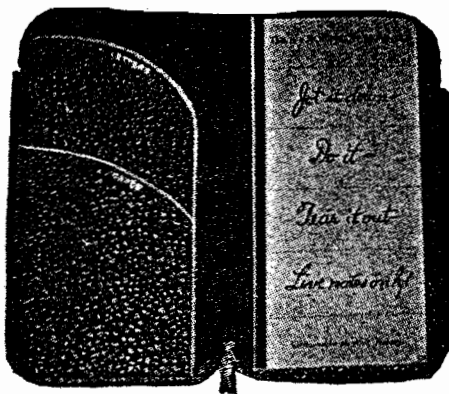

SEPARATE
COUPONS

TEAR
OUT
WHEN
ATTENDED
TO

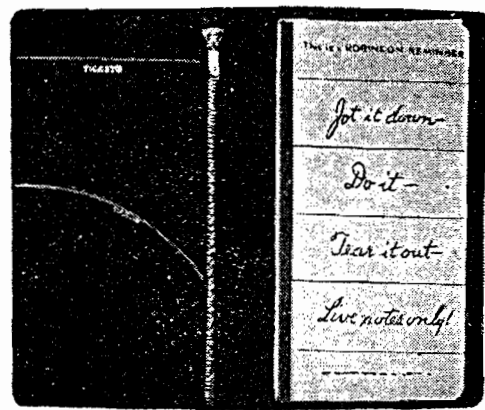

No. 51 WALLET-ZIP STYLE
7 1/4 x 4 1/4"

Number		Dealer Cost
514	Black Morocco Grain	\$2.25 — \$1.35
5182	Brown Morocco Grain	2.25 — 1.35
5183	Black Monkey Grain	2.25 — 1.35
5184	Brown Monkey Grain	2.25 — 1.35
5185	Black Boarded Cowhide	3.50 — 2.10
5186	Brown Boarded Cowhide	3.50 — 2.10
518	Pin Morocco	5.00 — 3.00
5126	Pigskin	5.00 — 3.00
410	Permanent Record Book	.75 doz. — .50
460	Extra Fillers, 6-coup.	\$1.20 doz. — .75

No. 10 ZIPPER POCKET WALLET STYLE
4 x 7 1/8"

Number		Dealer Cost
104	Black Morocco Grain	\$2.25 — \$1.35
1082	Brown Morocco Grain	2.25 — 1.35
1083	Black Monkey Grain	2.25 — 1.35
1084	Brown Monkey Grain	2.25 — 1.35
1085	Black Boarded Cowhide	3.50 — 2.10
1086	Brown Boarded Cowhide	3.50 — 2.10
108	Pin Morocco	5.00 — 3.00
1026	Pigskin	5.00 — 3.00
460	Extra Fillers, 6-coup.	\$1.20 doz. — .75
410	Permanent Record Book	.75 doz. — .50

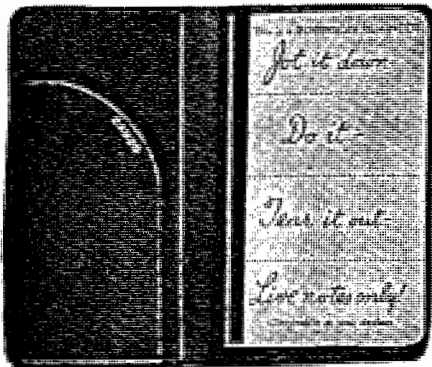

No. 34 VEST POCKET STYLE
3 x 5"

Number		Dealer Cost
344	Black Morocco Grain	\$1.00 — \$.65
3482	Brown Morocco Grain	1.00 — .65
3483	Black Monkey Grain	1.00 — .65
3484	Brown Monkey Grain	1.00 — .65
3485	Black Boarded Cowhide	1.50 — .90
3486	Brown Boarded Cowhide	1.50 — .90
348	Pin Morocco	2.50 — 1.50
3426	Pigskin	2.50 — 1.50

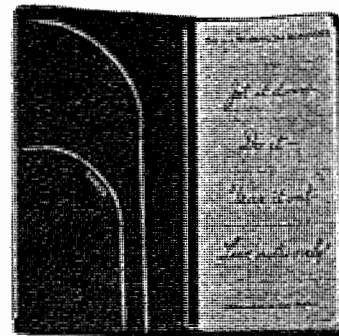

No. 46 COAT POCKET STYLE
3 1/2 x 7"

Number		Dealer Cost
464	Black Morocco Grain	\$1.50 — \$.90
4682	Brown Morocco Grain	1.50 — .90
4683	Black Monkey Grain	1.50 — .90
4684	Brown Monkey Grain	1.50 — .90
4685	Black Boarded Cowhide	2.50 — 1.50
4686	Brown Boarded Cowhide	2.50 — 1.50
468	Pin Morocco	3.50 — 2.10
4626	Pigskin	3.50 — 2.10
460	Extra Fillers, 6-coup.	\$1.20 doz. — .75
410	Permanent Record Book	.75 doz. — .50

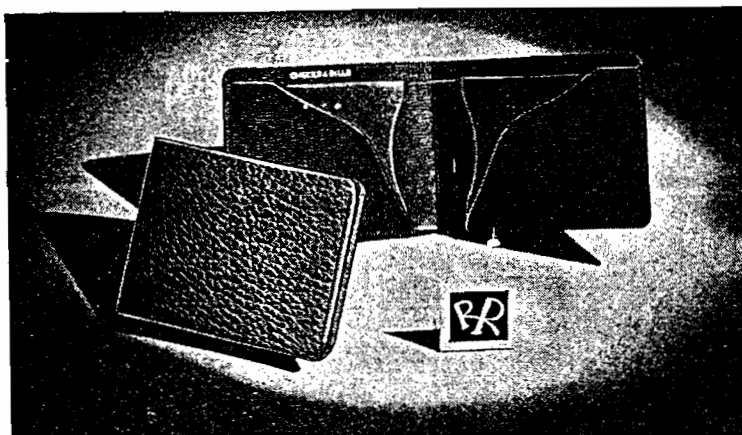

No. 42 EXTRA THIN STYLE
Attractive and Popular Priced 4 1/4 x 3 1/4"

Number		Dealer Cost
424	Black Morocco Grain	\$1.00 — \$.65
4282	Brown Morocco Grain	1.00 — .65
4283	Black Monkey Grain	1.00 — .65
4284	Brown Monkey Grain	1.00 — .65
4285	Black Boarded Cowhide	2.00 — 1.20
4286	Brown Boarded Cowhide	2.00 — 1.20
428	Pin Morocco	3.00 — 1.80
4226	Pigskin	3.00 — 1.80

ROBINSON PEN-in-INK

The Pen That Never Fails

HERE'S WHY—the Pen Point is always in the ink and ready to write—it rests in the socket that screws down as the ink is used.

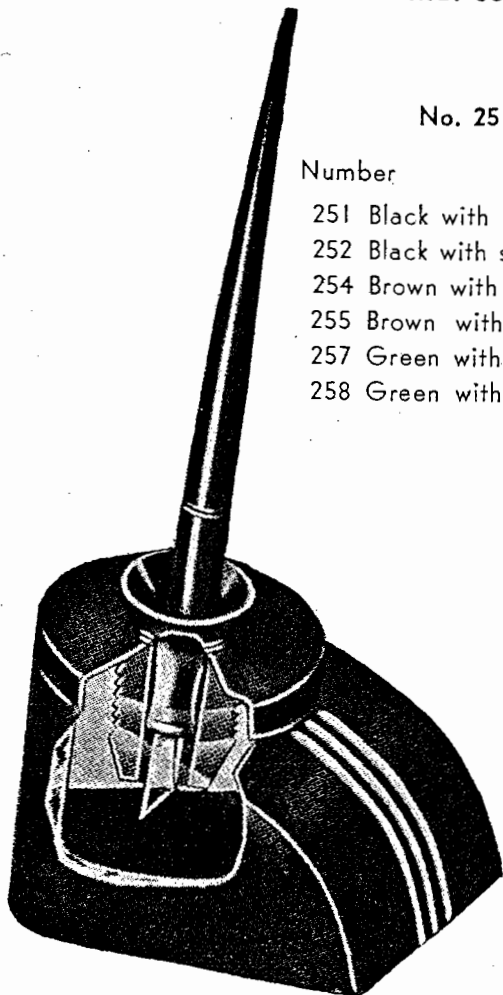

No. 25 STREAMLINE STYLE

Number	Dealer Cost
251 Black with gold stripe	\$2.45 — \$1.47
252 Black with silver stripe	2.45 — 1.47
254 Brown with gold stripe	2.45 — 1.47
255 Brown with silver stripe	2.45 — 1.47
257 Green with gold stripe	2.45 — 1.47
258 Green with silver stripe	2.45 — 1.47



No. 30 PERPETUAL CALENDAR

Number	Dealer Cost
303 Black	\$3.95 — \$2.37
304 Brown	3.95 — 2.37
305 Green	3.95 — 2.37

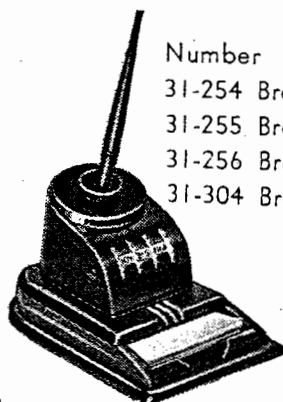

Number	Dealer Cost
31-254 Brown—No Calendar gold stripes	\$5.00 — \$3.00
31-255 Brown—No Calendar silver stripes	5.00 — 3.00
31-256 Brown—No Calendar red stripes	5.00 — 3.00
31-304 Brown—with Perpetual Calendar	6.50 — 3.90

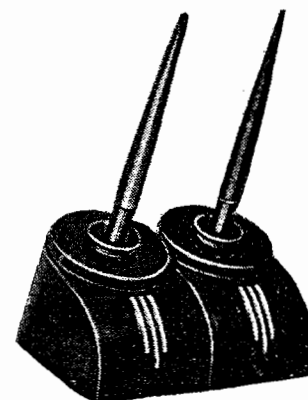

No. 16 DOUBLE STYLE for Red and Black Ink

Number	Retail Cost
161 Black with red and silver stripes	\$5.00 — \$3.00

Also Red and Black Pens

E-ject-R PENS and NIBS

Number	Dealer Cost
680 ROBINSON E-ject-R PEN, with nib	\$1.25 — \$.75
6800 ROBINSON E-ject-R Nibs (Extra Fine, Fine, Medium or Broad)	.35 — .23

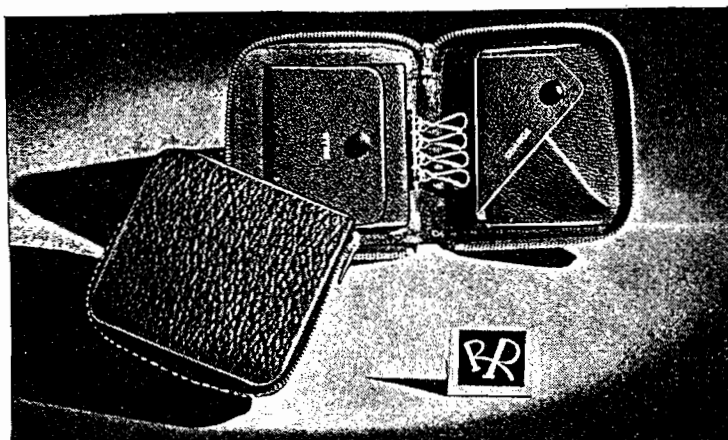

No. 24 CARRY-ALL STYLE

Holds Change, Bills and Keys 3 1/2 x 3 3/4"

Number	Dealer Cost
244 Black Morocco Grain	\$1.50 — \$.90
2482 Brown Morocco Grain	1.50 — .90
2483 Black Monkey Grain	1.50 — .90
2484 Brown Monkey Grain	1.50 — .90
2485 Black Boarded Cowhide	2.50 — 1.50
2486 Brown Boarded Cowhide	2.50 — 1.50
248 Pin Morocco	3.50 — 2.10
2426 Pigskin	3.50 — 2.10

DISTINCTIVE CUTS FOR MANY USES



BUSINESS CARD OR SMALL BLOTTER SIZE

No. 23 \$2.00 Each



LETTER HEAD
OR ENVELOPE SIZE

No. 24 \$2.50 Each

A SIZE FOR
MANY USES

No. 25 \$3.00 Each



SUPPLY
YOUR OWN
WORDS

No. 26
\$2.50 Each



No. 27 \$2.00 Each

No. 28



\$1.00 Each

No. 29



\$1.25 Each

No. 30



\$1.50
Each

EVERY PICTURE TELLS A STORY

CUTS AS SHOWN ARE ACTUAL SIZE



No. 31



No. 32

No. 31
\$1.00
Each

No. 32
\$1.00
Each

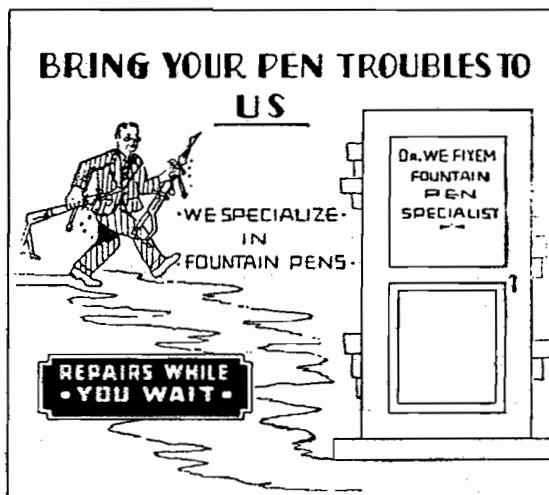

No. 33
\$2.50
Each

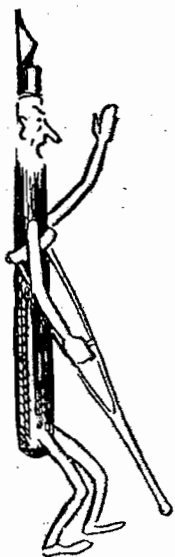

No. 34



No. 35

No. 34
\$1.25
Each

No. 35
\$1.25
Each

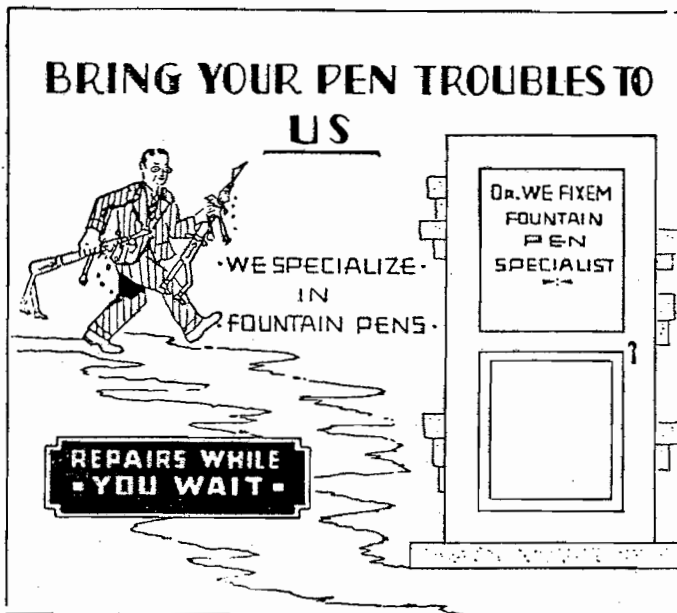

No. 36
\$3.00
Each

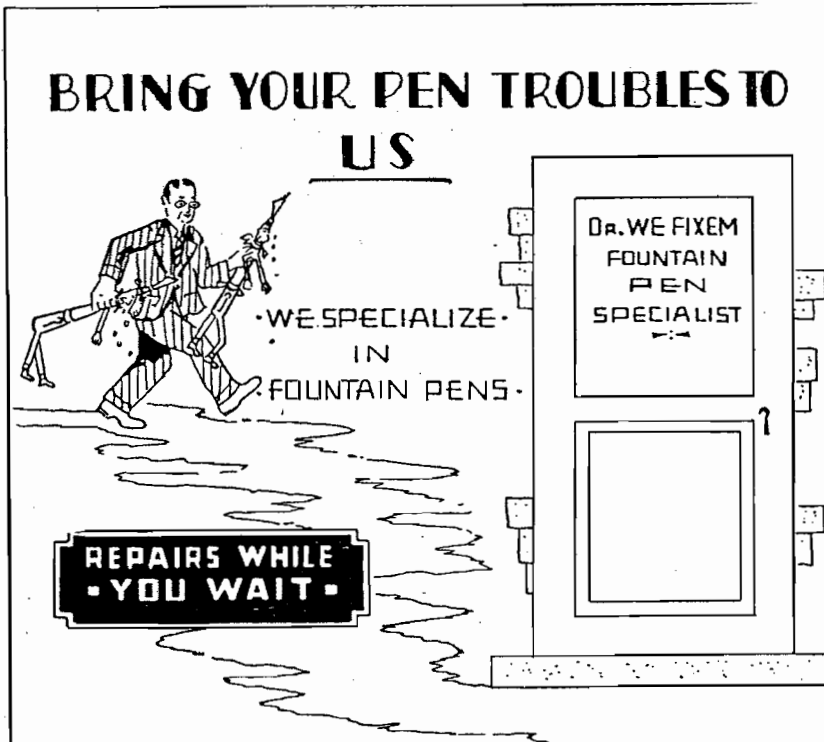

No. 37
\$3.50
Each

No. 38
\$1.50
Each

SELL YOUR SERVICE WITH OUR CUTS

A Proven Profit Producer *The Improved* FRANKLIN SIGNET EMBOSSER

EQUIPPED AS FOLLOWS:

- ONE FRANKLIN SIGNET EMBOSSER
with cord, plug and exclusive
"FINGER TIP HEAT CONTROL."
- ONE PEN ATTACHMENT—
automatically self aligning for any size pen
or pencil . . . prints complete name in one
operation.
- ONE ROLL OF GENUINE GOLD LEAF
23 karat, full one inch wide.
- TWO SETS OF DURA CAST TYPE
each in a handy type box.

This Size Type }
for Leather— } ROBERT OLIVER

This Size Type }
for pens— } THOMAS F. GRAY

- TYPE TWEEZERS
- FLANNEL FOR FINISHING
- PRACTICE EQUIPMENT—pieces of leather
and pen barrel for practicing.
- COMPLETE SET OF INSTRUCTIONS

INCREASE SALES BY STAMPING NAMES OR
INITIALS ON

Billfolds, Book Covers, Leather Cases, Fountain Pens,
Pens and Pencil Sets, Playing Cards, Stationery, Un-
breakable Crystals, Cardboard or Silk Lined Jewelry
Cases or Boxes.

FREE!!!

This beautiful mahog-
any finished type cabi-
net with purchase of
any 6 sets of type!
Holds 8 sets of type—
with drawer for leaf
and supplies.

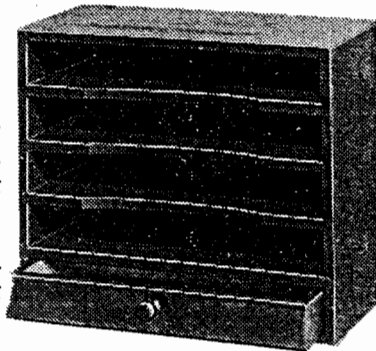

Ordered Separately \$2.50

De Luxe Model B
Neat and Compact—Measures 8" x 7" x 7"



Mounted on Base Drawer for Supplies

Complete
as
described **\$24.50**

Ready to use on 110-Volts—
A.C. or D.C.

Shipping weight approx. 12 pounds

No complicated gadgets to re-
move and fuss with when chang-
ing names. Type sets directly
into machine—in full view of
operator.

QUICK STARTING HEAT. Ma-
chine may be set at correct heat
for continuous stamping on leather
goods, pens, etc.
Ideal for Demonstration Sales.

RESULTS—same as costlier ma-
chines.

DURA CAST TYPE CAN BE USED ON

LEAF AND FOILS

23K Gold Leaf—10 ft. x 1 in. wide
per roll \$1.00

Imitation gold, aluminum,
100 ft. x 3/4 in. per roll 75c

Colored Foils—
blue, ruby, green, black
100 ft. x 3/4 in. per roll 75c
other widths in proportion
specify width when ordering

ROBERT OLIVER
No. 2430—12 pt.
Complete set.....\$2.00

ROBERT OLIVER
No. 2432—12 pt.
Complete set.....\$2.00

ROBERT OLIVER
No. 2430 and No. 2432
used in combination

Mr. and Mrs. Fred E. Stanley
No. 2440—12 pt.
Caps. and lower case
Complete set.....\$4.00

THOMAS F. GRAY
No. 2411—Fountain Pen
Type
Complete set.....\$4.50

IMPORTANT! Specify make of machine
when ordering pen type—or send a
sample of type you now use on pens.

EMBLEMS for Fraternal Organizations

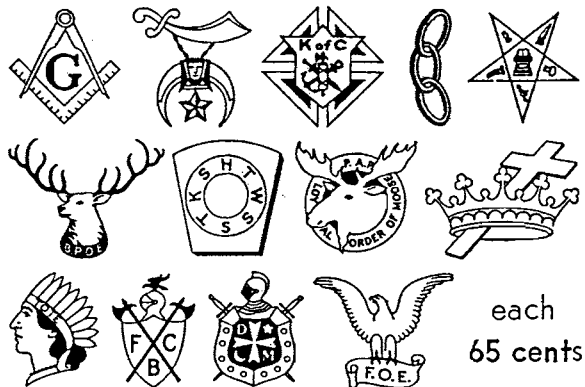

each 65 cents
Complete set (13) \$5.00

For other and special emblems send
sketch or copy for quotation

Z ATTACHMENT—for stamping optical
cases, zipper tourist cases, etc...\$4.50

STATIONERY ATTACHMENT — for
stamping on stationery, playing cards
and greeting cards.....\$4.50

IMPRESSION PADS—for use with Sta-
tionery Attachment
bundle of 50 pads \$1.00

LCW No. 3691—18 pt.

ALICE Complete set.....\$3.75

R H E Y S O C
No. 721—36 pt. Mono-
gram

Complete set.....\$4.25

E H D No. 3621—18 pt.
Complete set.....\$3.75

P L G No. 3631—18 pt.
Complete set.....\$3.75

K T B No. 3641—18 pt.
Complete set.....\$3.75

S R T No. 3661—18 pt.
Complete set.....\$3.75

G H R No. 3671—18 pt.
Caps. only
Complete set.....\$3.75

ellen coleman
Lower case only
Complete set.....\$3.75

Ellen Coleman
Caps. and lower case
2 complete sets....\$7.50

M C B No. 3681—18 pt.
Caps. only
Complete set.....\$3.75

Ω Δ Ε Greek Letters
Complete set.....\$3.75

ANY GOLD STAMPING MACHINE

Please Read—Then Order

TERMS AND INSTRUCTIONS FOR ORDERING

As a suggestion, to avoid delay in shipping your first order, include remittance in full.

OPEN ACCOUNTS—Our terms to responsible merchants, who have an established credit or satisfactory rating in the commercial agencies and who can furnish references acceptable to us, are 2%-10 days or net 30 days on all merchandise.

DEPOSITS

We require a deposit equal to 20% on all C. O. D. orders.

ORDERS LESS THAN \$3.00

Please send remittance in full with orders for \$3.00 or less. You save at least 20c C. O. D. and money order fees by doing so.

We will accept payments in U. S. Postage Stamps (small denomination please).

OUR SHIPPING FACILITIES

We ship all orders the same day we receive them whenever possible.

Our liberal money-back guarantee proves to you beyond a doubt that we have absolute confidence in our goods.

OUR MONEY BACK GUARANTEE

We absolutely agree to refund your money (less 10 percent for handling charges) for any merchandise that you cannot sell, or do not wish to keep, returned to us in first-class condition within 30 days from date of purchase.

HIGHEST PRICES PAID FOR OLD GOLD POINTS WE OFFER

10 K	...	PER DWT	...	67c
14 K	...	PER DWT	...	94c

Prices Subject to Change Without Notice

SEND YOUR OLD GOLD POINTS IN NOW
(We Do Not Buy Gold in Any Other Form)

SUPPLEMENT TO



CATALOG

PRICE CHANGES

- ★ Take advantage of the new low prices for the items illustrated in this supplement.
- ★ Compare with our last catalog.
- ★ See how our increasing volume enables us to offer you these outstanding values.
- ★ Use this supplement together with our last catalog for ready reference for all of your Pen Repair Supply needs. All other items shown in our last catalog are still available — AT PRICES LISTED THEREIN.

PENCRAFT, INC. - 5 BROMFIELD ST. - BOSTON, MASS.

FIRST QUALITY HARD IRIDIUM 14K GOLD POINTS

LARGER SIZES — BETTER VALUE THAN EVER — AT A LOWER PRICE

ORDER SAMPLES AND COMPARE WITH ANY YOU HAVE USED

Tipped with the highest quality IRIDIUM to insure long wear, smoothness and complete writing satisfaction. High standards of manufacture plus rigid inspection is your guarantee of absolute quality.

Complete
Assortment
\$3.75

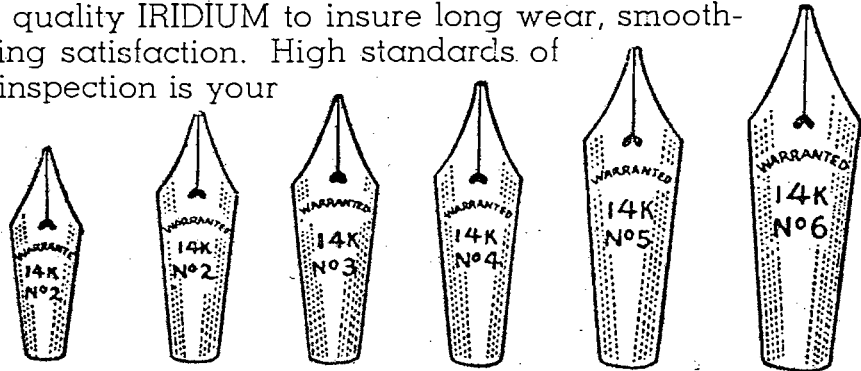

Each	35c	48c	60c	70c	80c	90c
Dozen	\$4.00	\$5.50	\$7.00	\$8.20	\$3.40	\$10.50

SAVE MORE THAN HALF ON THIS ASSORTMENT

Special value 12 gold pen point assortment with alloy IRIDIUM tip points. Good value.

Per Dozen \$5.00

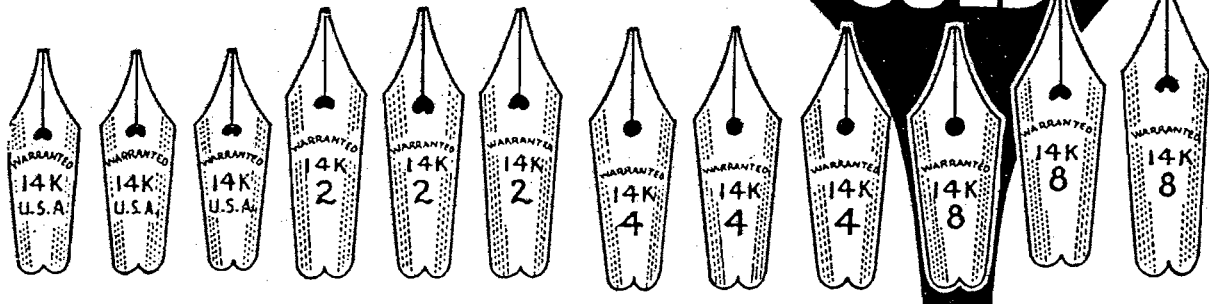

Alloy Iridium Tip Points 14K Gold

No. 19.....	Each 25c	Doz. \$3.00	No. 28.....	Each 43c	Doz. \$5.00
No. 21.....	Each 32c	Doz. 3.70	No. 31.....	Each 47c	Doz. 5.50
No. 23.....	Each 34c	Doz. 3.95	No. 32.....	Each 47c	Doz. 5.50
No. 24.....	Each 35c	Doz. 4.00	No. 50.....	Each 70c	Doz. 8.25

DURIUM PEN POINTS

A new point far superior to the gold-plated or plain steel point. Smooth writing, non-tarnishable Durium Pen Points will give complete satisfaction.

Sizes 2 and 4 35c doz. Gross, \$2.90
 Sizes 6, 7 and 8 40c doz. Gross, \$3.00

Durium Two-Tone Nibs

4 40c doz. \$3.50 gross
 6 and 8 50c doz. \$3.75 gross

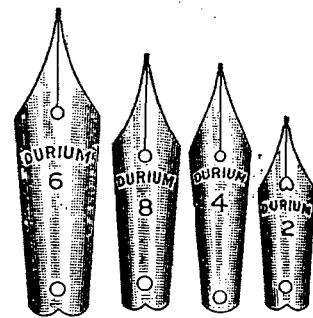

PENCRAFT, INC., 5 BROMFIELD STREET, BOSTON, MASS.

STAINLESS STEEL BALL POINTED NIBS

Non-corrosive, stainless steel, gold-plated points

25c dozen \$2.25 gross



GOLD PLATED POINTS

Small points, dozen 15c Gross \$1.50
 Large points, dozen 20c Gross 1.90



STAINLESS CORROSION-PROOF

14K Gold Plated
 F. P. Points
 5c Each
 45c Doz.
 Gross \$4.25

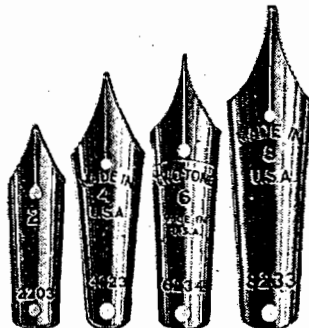

TWO-TONE

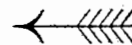

Dozen 50c
 Gross \$4.75

RADIITE IRIIDIUM TIPPED POINTS

Made like the best quality gold nib highly-polished and non-tarnishable. These points will wear a lifetime.

Sizes 1 to 6 each 13c
 Dozen \$1.25
 Size 8 each 18c
 Dozen \$1.75

RADIITE IRIIDIUM TIPPED TWO-TONE GOLD PLATED NIB



Sizes 2—4—5
 Each 15c
 Dozen \$1.50

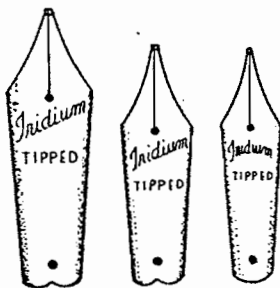
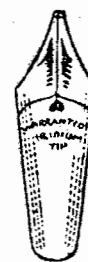

IRIDIUM TIPPED DURIUM SMOOTH WRITING NIBS

Each 10c
 Dozen \$1.00
 Gross \$9.00

PEN REPAIR ENVELOPES

SAFETY FROM THEFT AND LOSS
 REQUIREMENTS
 GOLD PEN
 Size
 Color
 Style
 Straps
 Point
 Cap
 Color
 Material
 Brand
 Model
 Serial
 Number
 Date
 and
 Adjust
 Balance
 and
 Order
 Express
 PENCILS
 Tip
 Check
 Number
 Serial
 Number
 Date
 and
 Order
 Express

This space for your address

FOUNTAIN PENS
 MECHANICAL PENCILS
 REPAIRED
 PROMPT - EFFICIENT SERVICE

MAKE _____ DATE _____
 REPAIR NO. _____ DEALER _____
 OWNER _____

100—60c 500—\$2.25 1000—\$4.00
 3000 Your Name and Address Imprinted \$15.00
 5000 Your Name and Address Imprinted \$23.50

THESE LOW PRICES CANNOT BE
 DUPLICATED

LEADING PEN PARTS HOUSE IN U. S. A.

DESK SET ORNAMENTS

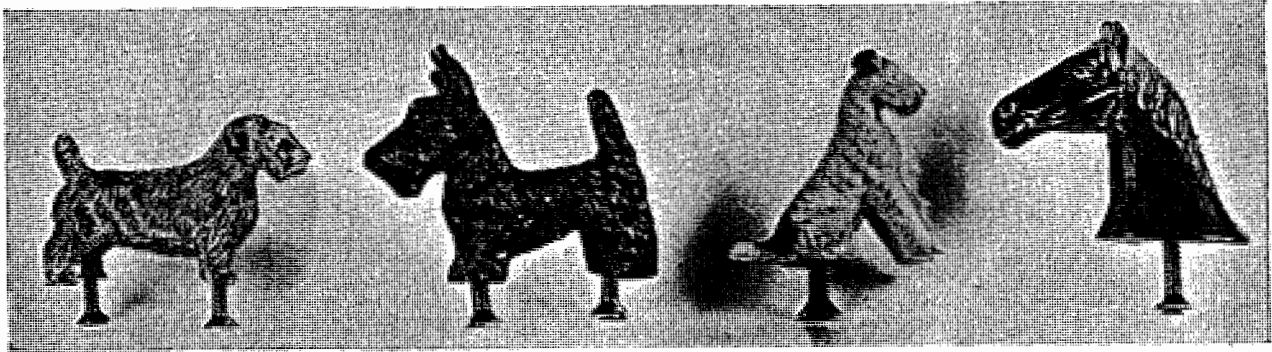

No. 20

No. 30

No. 40

No. 50

The above figures are 2/3 of actual size and come equipped with screw for attaching to base.

Price Each 20c

Dozen \$1.80

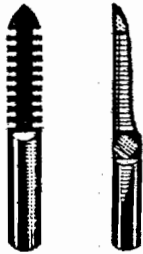

COMB FEEDS
(Clean Cut)

10c Each

60c Doz.

3 Doz. — \$1.50

PARKER PRESSURE BARS

For Parker Duofold and Parker
Lucky Curve

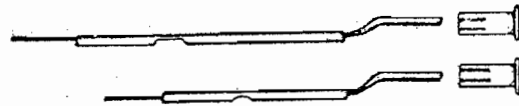

10c each—80c dozen

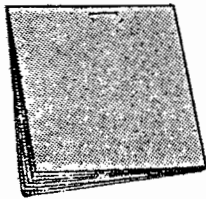

Smoothen Points with
TRIPLE-O-FRENCH
EMERY PAPER

6 Sheets 15c



DIAPHRAGM FOR PARKER FILLER UNIT

SLENDER (Ladies)

STANDARD (Medium)

OVERSIZE (Large)

Each 10c

Doz. 80c



PARKER
DUOFOLD CLIPS

Each 25c

Doz. \$2.40

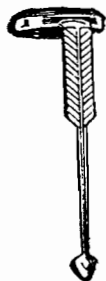

PARKER
VACUUM
CLIPS

Gold Filled
or
Chrome
40c Each

PARKER CLIP SCREWS
or **BLIND CAP SCREWS**



Each 5c

Doz. 50c

BLIND CAP BANDS Ea. 5c
Gold Filled or Chrome Doz. 50c

PARKER
DUOFOLD
BLIND CAPS
(End Caps)

Senior
Junior
Lady
10c Each
80c Dozen



SEND US YOUR OLD GOLD POINTS
APPLY SAME TOWARDS PURCHASES — WE PAY 94c DWT.

PENCRAFT, INC., 5 BROMFIELD STREET, BOSTON, MASS.

IT PAYS TO
USE THE BEST



RUBBER SACS
ARE MADE OF
PURE GUM RUBBER

Guaranteed
Not To Swell
From Acid Inks

Will Not
Dry or Crack

Guaranteed
Always Fresh

1 Dozen \$.40
3 Dozen 1.00
100 Sacs 2.25
200 Sacs 4.00
300 Sacs 5.00
500 Sacs 6.50
1000 Sacs 10.00











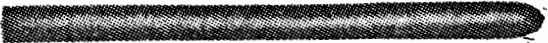
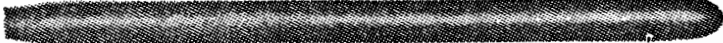





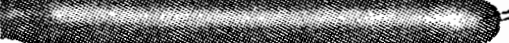

2000 or over
@ \$9.00 per M

SAC HOOK

For Removing
Old Sac From
Barrel

Each 10c
Doz. 75c

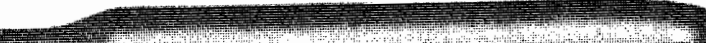
ACTUAL SIZE

	No. 12S
	14EL
	15S
	15L
	15EL
	16L
	16S
	17EL
	17S
	18L
	18S
	18EL
	19EL
	20EL
	20M
	20S
	22L
	23M
	23EL
	23L
	24EL

WE OPERATE THE BEST EQUIPPED REPAIR SHOP

DISTINCTIVE CUTS FOR MANY USES

BUSINESS CARD OR SMALL BLOTTER SIZE

No. 23 \$1.25 Each



LETTER HEAD
OR ENVELOPE SIZE

No. 24 \$1.75 Each

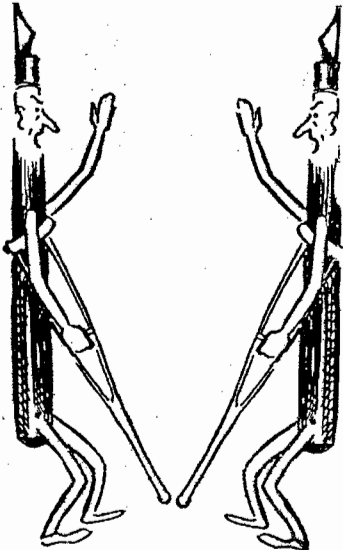

No. 34
\$1.00
Each

No. 35
\$1.00
Each

No. 34

No. 35

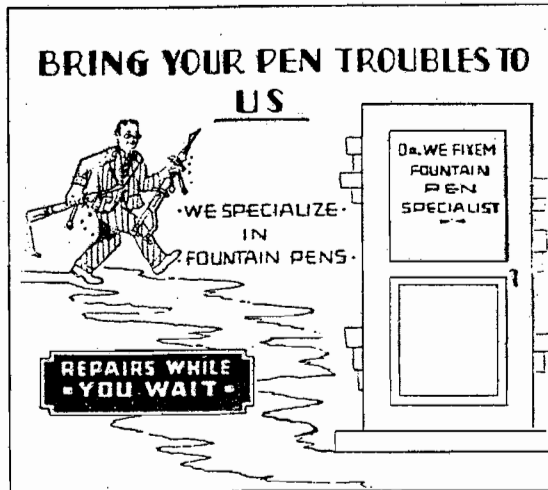

No. 33
\$1.75
Each

OTHER CUTS REDUCED

No. 25 Now \$2.25
No. 26 " 1.75
No. 28 "75
No. 31 "75
No. 32 "75
No. 36 " 2.25
No. 37 " 2.50
No. 38 " 1.25

FILL IN
YOUR OWN
WORDS

No. 27 \$1.50 Each



No. 29



\$1.00 Each

No. 30



\$1.25
Each

EVERY PICTURE TELLS A STORY

A WONDERFULL SALES STIMULATOR

We have introduced this item late last fall and made a decided hit—not saying anything about the added business it has brought in on other merchandise.

ORDER A SAMPLE AND BE CONVINCED

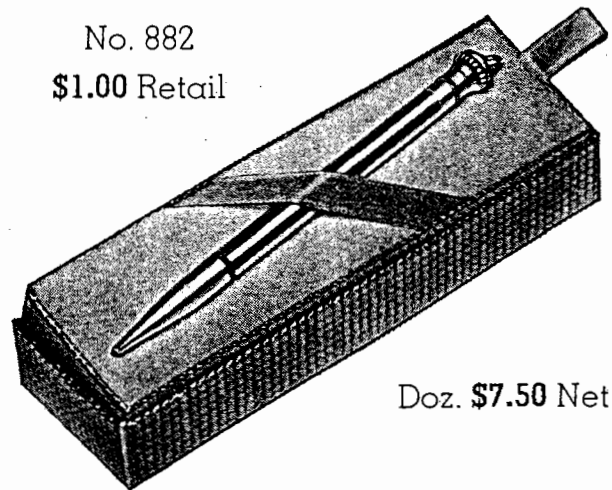

No. 882
\$1.00 Retail

Doz. \$7.50 Net

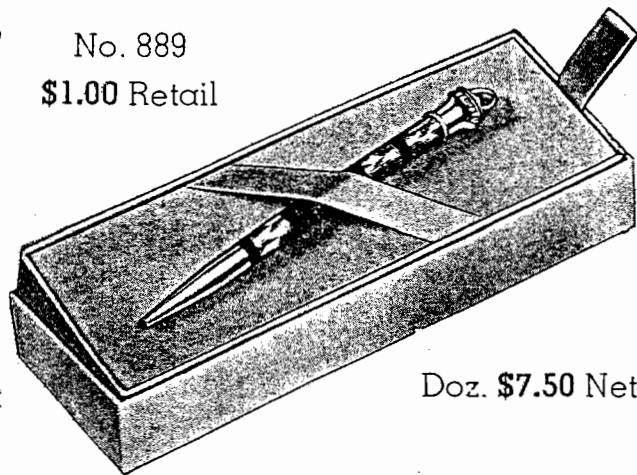

No. 889
\$1.00 Retail

Doz. \$7.50 Net

A pencil so designed that strength is not sacrificed for daintiness. Just what every woman wants for her purse. Gold filled with beautiful fancy chased barrel. Comes in a distinctive individual box. Can also be had in sterling silver.

Light weight, match-like slenderness, make this black-and-gold masterpiece the pencil for club women, bridge players, and others. We are receiving hundreds of rush repeat orders on this quick seller. Order three dozen and get display free.

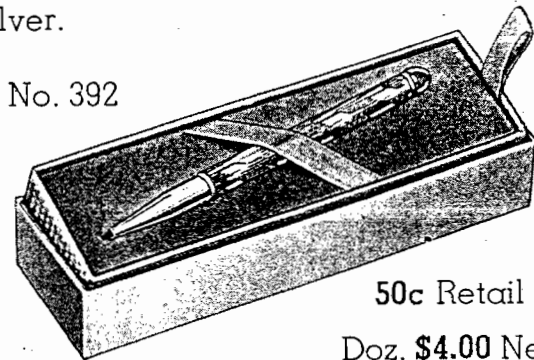

No. 392

50c Retail
Doz. \$4.00 Net

The smallest gold-filled pencil made. Only $2\frac{3}{4}$ in. long. Most suitable for bridge prizes, favors, and other purposes where a dainty but practical 50c article of real quality is desired. Each pencil comes in attractive individual box. Sterling silver same price.

A. T. CROSS PENCILS

—a quality line that attracts additional pencil business irrespective of what other styles you carry. Every pencil is guaranteed. They are simple in operation, use standard size leads, and are made by fine craftsmen from the finest materials. With ninety-two years' experience behind them, they must be right. Stock them, show them, and you will sell them.

A beautiful telescopic pencil in 12 Kt $1/20$ th gold, handsomely chased, with three enameled black inserts set in contrastingly. Size closed, to slip in vest-pocket or attach to chain, 3 in. Extended, for writing, $5\frac{1}{8}$ in. Though priced low, this is a high quality item in every respect.



No. 125
\$3.50 Retail
\$2.10 Net

SPECIAL FOR LIMITED TIME ONLY

This Proven Profit Producer *The Improved*

FRANKLIN SIGNET EMBOSSER

EQUIPPED AS FOLLOWS:

- ONE FRANKLIN SIGNET EMBOSSER with cord, plug and exclusive "FINGER TIP HEAT CONTROL".
 - ONE PEN ATTACHMENT — automatically self aligning for any size pen or pencil . . . prints complete name in one operation.
 - ONE ROLL OF GENUINE GOLD LEAF 23 karat, full one inch wide.
 - TWO SETS OF DURA CAST TYPE each in a handy type box.

This Size Type for Leather—	} ROBERT OLIVER
This Size Type for Pens—	} THOMAS F. GRAY
 - TYPE TWEEZERS
 - FLANNEL FOR FINISHING
 - PRACTICE EQUIPMENT—pieces of leather and pen barrel for practicing.
 - COMPLETE SET OF INSTRUCTIONS
- INCREASE SALES BY STAMPING NAMES OR INITIALS ON**

Billfolds	Pen and Pencil Sets
Book Covers	Playing Cards
Leather Cases	Stationery
Fountain Pens	Unbreakable Crystals
Silk Lined Jewelry Cases or Boxes	

DE LUXE MODEL B
Neat and Compact—
Measures 8" x 7" x 7"



Mounted on Base Drawer
for Supplies

Complete
as
described **\$22.50**

Ready to use on 110-Volts—
A.C. or D.C.

Shipping weight approx. 12 pounds

No complicated gadgets to remove and fuss with when changing names. Type sets directly into machine—in full view of operator.

QUICK STARTING HEAT. Machine may be set at correct heat for continuous stamping on leather goods, pens, etc.

Ideal for Demonstration Sales.

RESULTS—same as costlier machines.

ORDER ONE NOW FOR THE COMING SEASON